

2022-2023

माढा तालुका शिक्षण प्रसारक मंडळ संचलित,

के.एन.भिसे आर्ट्स, कॉमर्स अँड विनायकराव पाटील सायन्स
कॉलेज, विद्यानगर, भोसरे

महाविद्यालयीन क्रिडा महोत्सव २०२२-२३.

सुचना

वरिष्ठ महाविद्यालयातील कला, वाणिज्य व विज्ञान शाखेतील सर्व विद्यार्थी विद्यार्थीनींना सुचीत करण्यात येते की, दि. १८/०५/२०२३ ते २३/०५/२०२३ या कालावधीमध्ये महाविद्यालयात क्रिडामहोत्सव स्पर्धेचे आयोजन करण्यात आले असून इच्छुक स्पर्धकांनी वैयक्तिक त्र सांघिक स्पर्धकरिता खालील प्राध्यापकाकडे नाव नोंदणी करावी.

अ.क्र.	स्पर्धेचे नांव	दिनांक	वेळ	मुले नोंदणी	मुली नोंदणी
१	क्रिकेट (मुले)	१८-०५-२०२३ ते २१-०५-२०२३	स.९.०० पासून	डॉ. पी. आय. तांबिले	-
२	१०० मी.धावणे (मुले/मुली)	२२-०५-२०२३	स.९.०० पासून	डॉ. पी. आय. तांबिले	डॉ. ए. पी. पोळ
३	लांबऊडी (मुले/मुली)	२२-०५-२०२३	स.१०.०० पासून	डॉ. पी. आय. तांबिले	डॉ. एस. व्ही .मोहीते
४	गोळाफेक (मुले/मुली)	२२-०५-२०२३	स.११.०० पासून	डॉ. पी. आय. तांबिले	डॉ. एम. एन. साळुंके
५	बॅडमिन्टन (मुले/मुली)	२३-०५-२०२३	स.९.३० पासून	प्रा. ए.एम. गोयल	डॉ.व्ही. बी. वाघमारे



प्रभारी प्राचार्य
के.एन.भिसे आर्ट्स, कॉमर्स अँड
विनायकराव पाटील सायन्स कॉलेज,
विद्यानगर भोसरे, जि. सोलापूर

माढा तालुका शिक्षण प्रसारक मंडळ संचलित,

के.एन.भिसे आर्टस्, कॉमर्स अँड विनायकराव पाटील सायन्स
कॉलेज, विद्यानगर, भोसरे

महाविद्यालयीन क्रिडा महोत्सव २०२२-२३.
स्पर्धेचे वेळापत्रक

अ.क्र.	स्पर्धेचे नांव	दिनांक	वेळ
१	क्रिकेट (मुले)	१८-०५-२०२३ ते २१-०५-२०२३	स.९.०० वा.पासून
२	१०० मी.धावणे (मुले/मुली)	२२-०५-२०२३	स.९.०० पासून
३	लांबऊडी (मुले/मुली)	२२-०५-२०२३	स.१०.०० पासून
४	गोळाफेक (मुले/मुली)	२२-०५-२०२३	स.११.०० पासून
५	बॅडमिन्टन (मुले/मुली)	२३-०५-२०२३	स.९.३० पासून

स्पर्धेचे नियम —

- क्रिकेट (टेनिस बॉल) चे पुरुष गटातील शाखानिहाय आर्टस (भाग १,२,३) कॉमर्स (भाग १,२,३) सायन्स (भाग १,२,३) असे ९ संघ घेण्यात येईल.
- क्रिकेट चे पुरुष गटातील दररोज ८ षटकांचे दोन सामने बाद पध्दतीने घेण्यात येतील.
- क्रिकेट स्पर्धेसाठी प्रत्येक संघाने क्रिडा साहित्य स्वतः आणावे स्पर्धेसाठी फक्त विकेट व बॉल उपलब्ध करून दिले जातील
- क्रिकेट स्पर्धेत सहभागी होणाऱ्या खेळाडूंनी स्वतःच्या क्रिडा गणवेशात सहभागी व्हावे.
- स्पर्धेसाठी सहभाग नोंदणी दिनांक १७/०५/२०२३. दु. ३.०० पर्यंत संबंधीत शिक्षकांकडे करावी.
- स्पर्धेत सहभागी होणाऱ्या खेळाडूंना सर्व स्पर्धेमध्ये सहभागी होता येईल.

Ambik



Baif
प्रभारी प्राचार्य
के.एन.भिसे आर्ट्स, कॉमर्स अँड
विनायकराव पाटील सायन्स कॉलेज,
विद्यानगर भोसरे, जि. सोलापूर

Madha Taluka Shikshan Prasarak Mandal's

**K. N. BHISE ARTS, COMMERCE AND VINAYAKRAO PATIL
SCIENCE COLLEGE, VIDYANAGAR, BHOSARE**

**Report of 100 Mts. Run. Competition
2022-23.**

Committee/ Department : Physical Education & Sports
Event : Cricket (men)
Date : 18/05/2023 to 21/05/2023.
Venue : K. N. Bhise Arts, Commerce and Vinayakrao
Patil Science College, Bhosare.

Aims and Objectives:

1. To Create awareness about the sports and game.
2. To Promote Physical fitness.

Activities: In the academic year 2022-23, Gymkhana Department organized following activity.

Sr. No	Activity	Date	No. of Participants
1	Cricket. (Men)	18/05/2023 to 21/05/2023	108

Support of Teaching and Non-Teaching Staff : All Staff members.

Outcomes:

1. The event promoted sports culture in the campus.
2. It created awareness about physical toughness and fitness.

I/c.Principal
**K.N.Bhise Arts,Commerce &
Vinayakrao Patil Science College**
Vidyanagar Bhosare,Dist-Solapur





Cricket Match Batsman play Cover drive



Cricket Match Bowling Action



Madha Taluka Shikshan Prasarak Mandals

K.N.BHISE ARTS COMMERCE & VINAYAKRAO PATIL SCIENCE COLLEGE, BHOSARE.

Intra College Sport Competition Year: - 2022/2023.

Name of the Event: Cricket (Men)

Date: 18-05-2023.

Lots

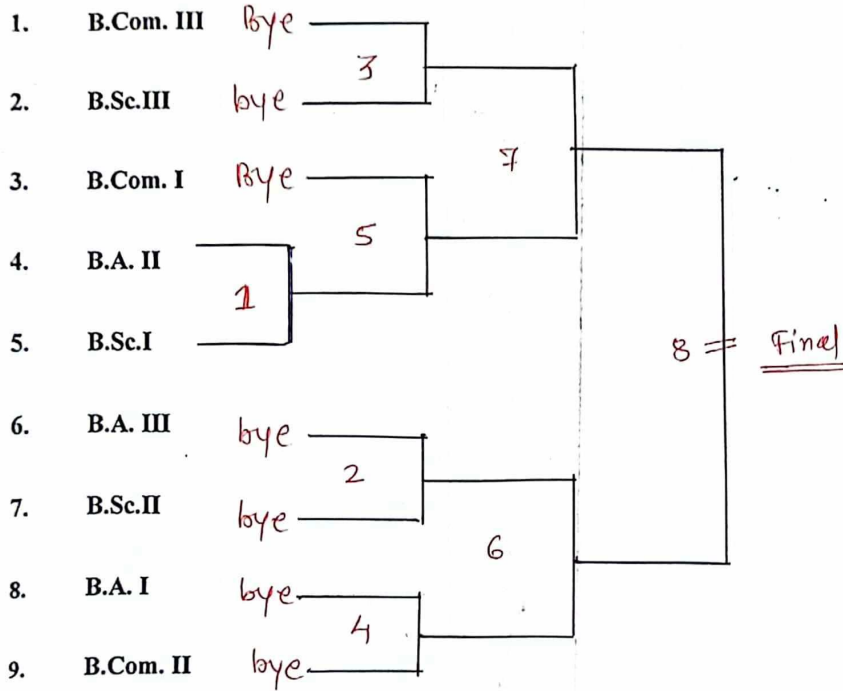

Pambhile

Atkar U

Gmnde

Tonape - K.S. R.S. Kharade

Shambhe

Kanade U.V.

Baumf

O.A. Mithani

Madha Taluka Shikshan Prasarak Mandals

K.N.BHISE ARTS COMMERCE& VINAYAKRAO PATIL SCIENCE COLLEGE, BHOSARE.

Intra College Sport Competition Year: – 2022/2023.

Name of the Event: Cricket Men. Team Name: - **B.A. I**

Date: 18-05-2023 to 21-05-2023.

Sr.No.	Name of the player	Class	Contact No	Signature
1	DHAGE DNYANESHWAR LAXMAN	BA.I	8010472906	डॉ. ड. ड. ड. ड.
2	SONMUKHE NIKHIL NAGANATH	BA.I	8080916325	ड. ड. ड.
3	THENGAL DASHRATH BABAN	BA.I	9075213069	ड. ड. ड. थेंगल
4	WAGH PRATHMESH SATISH	BA.I	8459959830	ड. ड. ड. वाघ
5	SUKALE VIKAS SHANKAR	BA.I	8605982561	ड. ड. ड. सुकले
6	BABAR SANDESH GOVARDHAN	BA.I	7620684486	ड. ड. ड. बाबर
7	KHARE KARAN GAUTAM	BA.I	8806757935	ड. ड. ड. खारे
8	SALUNKE RAMDAS BAJIRAV	BA.I	9096892890	ड. ड. ड. सलुंके
9	SURVASE ABHIJIT TANAJI	BA.I	9022885376	ड. ड. ड. सुरवसे
10	RAUT ABHISHEK SANTOSH	BA.I	8623085506	ड. ड. ड. राउत
11	SHINDE KALIDAS VASANT	BA.I	8275646421	ड. ड. ड. शिंदे
12	SURVE RAHUL DATTATRAYA	BA.I	9604403718	ड. ड. ड. सुरवे

Caption Name:-DHAGE DNYANESHWAR LAXMAN.

डॉ. ड. ड. ड.



Madha Taluka Shikshan Prasarak Mandals

K.N.BHISE ARTS COMMERCE & VINAYAKRAO PATIL SCIENCE COLLEGE, BHOSARE.

Intra College Sport Competition Year: – 2022/2023.

Name of the Event: Cricket Men. Team Name: - **B.A. II** Date: 18-05-2023 to 21-05-2023.

Sr.No.	Name of the player	Class	Contact No	Signature
1	MULANI SAJID HAJUALI	B.A.II	7666703722	S. h. Mulani
2	CHANDANE AKASH RAVINDRA	B.A.II	9627619260	Akash
3	MASTUD HARSHAD SUNIL	B.A.II	7517665101	Harshad
4	SATPUTE RUSHIKESH ARUN	B.A.II	7038957887	R. N. Satpute
5	THORAT RUSHIKESH BALAK	B.A.II	9130928075	B. Thorat
6	DHAYGUDE RUSHIKESH BHAGWAT	B.A.II	7888231318	Rushikesh
7	YADAV PRATHAMESH NAGNATH	B.A.II	7083319702	Prathamesh
8	GHUGE AUDUMBAR SANTOSH	B.A.II	9022365085	A. S. Ghuge
9	LONDHE UMESH SANTOSH	B.A.II	9021825097	Umesh
10	DIKOLE SURAJ BANDU	B.A.II	7058042343	S. B. Dikole
11	NAWALE SAGAR BALAJI	B.A.II	9022375371	S. Nawale
12	GHADAGE RUPESH BAJRANG	B.A.II	7620740102	R. B. Ghadage

Caption Name:-MULANI SAJID HAJUALI.

A. S. Ghuge





Madha Taluka Shikshan Prasarak Mandals

K.N.BHISE ARTS COMMERCE & VINAYAKRAO PATIL SCIENCE COLLEGE, BHOSARE.

Intra College Sport Competition Year: – 2022/2023.

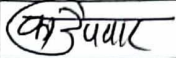
Name of the Event: Cricket Men. Team Name: - B.A. III Date: 18-05-2023 to 21-05-2023.

Sr.No.	Name of the player	Class	Contact No	Signature
1	PAWAR ONKAR HARI	B.A.III	8329792846	
2	GHADAGE AJAY NAVNATH	B.A.III	9922382893	
3	RANDAVE VINAY SHAHAJI	B.A.III	9156872407	
4	KANADE VISHAL VINOD	B.A.III	9075634890	<u>Kanade.v.v.</u>
5	UBALE ANURAG CHANDRAKANT	B.A.III	9689039155	<u>A.C. Ubale</u>
6	DHANE KARAN SHAHAJI	B.A.III	9767472975	<u>Karan Shane</u>
7	DHANE SURAJ SHIVAJI	B.A.III	9767472975	<u>S.S. Dhane</u>
8	SAWANT KEDAR TANAJI	B.A.III	9022177395	<u>K.T. Sawant</u>
9	VYAVAHARE SURAJ ANDHU	B.A.III	8956508894	<u>S.A. Vyavahare</u>
10	LENGARE VISHAL SANDIPAN	B.A.III	8407975544	<u>Pengare</u>
11	KUBER SOMNATH MAHAVIR	B.A.III	9356349359	<u>SbKuber</u>
12	TONAPE VISHAL VASANT	B.A.III	8408046940	<u>Tonape</u>

Caption Name:- PAWAR ONKAR HARI. Kanade.v.v.



Mudha Taluka Shikshan Prasarak Mandals

K.N.BHISE ARTS COMMERCE & VINAYAKRAO PATIL SCIENCE COLLEGE, BHOSARE.

Intra College Sport Competition Year: - 2022/2023.

Name of the Event: Cricket Men. Team Name: - **B.Com. I** Date: 18-05-2023 to 21-05-2023.

Sr.No.	Name of the player	Class	Contact No	Signature
1	MITHARI OM AVINASH	B.Com I	9325393199	O.A. Mithari
2	PATEL AMIT SHANKARLAL	B.Com I	7058748300	A.S.P.
3	UBALE VIVEKANAND VINOD	B.Com I	9579448409	V.V. Ubale
4	KADAM SATYAJIT BHAURAO	B.Com I	7020656965	Satya Jit
5	YADAV RUSHIKESH PANDURANG	B.Com I	7822943588	Yadav R.P.
6	PATHAN NAVAJ KARIM	B.Com I	9766317823	Pathan N.K.
7	KADAM PAVANRAJ RITIRAJ	B.Com I	9404136362	Pavan R.
8	LONDHE ONKAR RAMCHANDRA	B.Com I	9359686001	O.R. Londhe
9	UBALE GANESH BALASAHEB	B.Com I	7498575017	G.B. Ubale
10	GADE VAIBHAV SUDHIR	B.Com I	8379851331	Vaibhav S.
11	PATIL ADESH SANTOSH	B.Com I	9699473114	A.S. Patil
12	KOTHMIRE ABHISHEK SANTOSH	B.Com I	7410590629	Abhishek S.

Caption Name:-MITHARI OM AVINASH. O.A. Mithari









Madha Taluka Shikshan Prasarak Mandals

K.N.BHISE ARTS COMMERCE & VINAYAKRAO PATIL SCIENCE COLLEGE, BHOSARE.

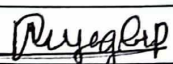
Intra College Sport Competition Year: – 2022/2023.

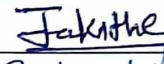
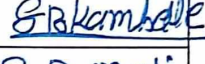
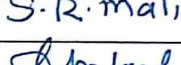
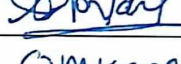
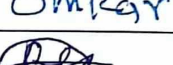
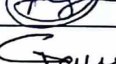
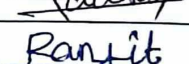
Name of the Event: Cricket Men. Team Name: - **B.Com. II** Date: 18-05-2023 to 21-05-2023.

Sr.No.	Name of the player	Class	Contact No	Signature
1	ATKAR VINAYAK SOMNATH	B.Com.II	9370186003	
2	GADEKAR RAHUL HARISHCHANDRA	B.Com.II	9922526989	
3	JAGTAP RUSHIKESH UTTAM	B.Com.II	8390804235	
4	KADAM SARANG SANTOSH	B.Com.II	7666240360	
5	KALUKHE JOTIRAM VISHNU	B.Com.II	8767171700	
6	KAMBLE SHIVRATNA BALASAHEB	B.Com.II	8411925746	
7	MALI SHASHIKANT RAJU	B.Com.II	7414914255	
8	PALASE AVDHUT HANUMANT	B.Com.II	8857917058	
9	SHELKE OMKAR LAXMAN	B.Com.II	8928601236	
10	SNCHETI PIYUSH SACHIN	B.Com.II	9075025946	
11	TONAPE GAURAV GOPAL	B.Com.II	9021375205	
12	WAGHMODE RANJIT BIBHISHAN	B.Com.II	9987649413	

Caption Name:- ATKAR VINAYAK SOMNATH.











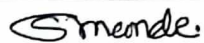
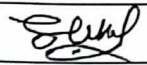

Madha Taluka Shikshan Prasarak Mandals

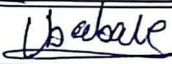
K.N.BHISE ARTS COMMERCE & VINAYAKRAO PATIL SCIENCE COLLEGE, BHOSARE.

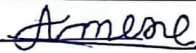
Intra College Sport Competition Year: – 2022/2023.

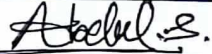
Name of the Event: Cricket Men. Team Name: - **B.Com. III** Date: 18-05-2023 to 21-05-2023.

Sr.No.	Name of the player	Class	Contact No	Signature
1	MANDE SUMIT SUNIL	B.Com. III	8483893855	
2	JAGTAP SHUBHAM MOHAN	B.Com. III	9096389472	
3	MOHITE VIJAY NAGNATH	B.Com. III	7972051819	
4	SAYYED NAWAZ MANSUR	B.Com. III	8600651494	N.M. sayyed.
5	FARAD VINAY SOMNATH	B.Com. III	8421894977	V. S. Farad
6	UBALE CHINTAMANEE BALASO	B.Com. III	7498750584	
7	PAWAR DHIRAJ UTTAM	B.Com. III	9307596928	
8	MULANI ARMAN MUNNA	B.Com. III	7498104886	
9	KALE ANAND LAXMAN	B.Com. III	9022371592	
10	PAWAR KIRAN ANIL	B.Com. III	9604053329	K. A. Pawar
11	SHAIKH ABDUL NISAR	B.Com. III	8180015175	
12	NIMBHORKAR DIPAK APPARAO	B.Com. III	7504529696	

Caption Name:- MANDE SUMIT SUNIL. 



Madha Taluka Shikshan Prasarak Mandals

K.N.BHISE ARTS COMMERCE & VINAYAKRAO PATIL SCIENCE COLLEGE, BHOSARE.

Intra College Sport Competition Year: – 2022/2023.

Name of the Event: Cricket Men. Team Name: - **B.Sc. I** Date: 18-05-2023 to 21-05-2023.

Sr.No.	Name of the player	Class	Contact No	Signature
1	MOTE PRATHAMESH BIBHISHAN	B.Sc. I	9284571682	<u>B.mote</u>
2	BHONG NIKHIL PANDURANG	B.Sc. I	8010802161	<u>Bhong.N.P.</u>
3	SHINDE SWAPNIL TANAJI	B.Sc. I	9730503894	<u>S.hinde.ST</u>
4	MARATHE NAGESH SIDDHU	B.Sc. I	7499477796	<u>Marathe</u>
5	LOKARE TUKARAM DARYABA	B.Sc. I	9763123651	<u>Lokare.T.D</u>
6	TONAPE KETAN SATISH	B.Sc. I	9158806780	<u>Tonape.K.S</u>
7	JADHAV RAJ VIKRAM	B.Sc. I	7887988291	<u>Jadhav</u>
8	GOPHAN MAHESH VISHNU	B.Sc. I	8767007086	<u>M.V.Gophan</u>
9	GOADASE SHUBHAM LAXMAN	B.Sc. I	8767654814	<u>Shubham</u>
10	ARKILE AUDUMBAR SHIVAJI	B.Sc. I	8767983782	<u>Arkile</u>
11	BHONG GANESH SUBHASH	B.Sc. I	9673813379	<u>Bhong</u>
12	LONDHE DHANAJI SHAHAJI	B.Sc. I	9579540056	<u>Dshone</u>

Caption Name:-MOTE PRATHAMESH BIBHISHAN. Tonape.K.S.



Madha Taluka Shikshan Prasarak Mandals

K.N.BHISE ARTS COMMERCE & VINAYAKRAO PATIL SCIENCE COLLEGE, BHOSARE.

Intra College Sport Competition Year: – 2022/2023.

Name of the Event: Cricket Men. Team Name: - **B.Sc.II**

Date: 18-05-2023 to 21-05-2023.

Sr.No.	Name of the player	Class	Contact No	Signature
1	BHOSALE RITESH VIJAYKUMAR	B.S.c.II	7083845821	R.V. Bhosale.
2	RAUT PRAVIN MARUTI	B.S.c.II	9545652041	Raut P.M.
3	KEDAR ROHIT ANKUSH	B.S.c.II	7768032749	R. Kedar
4	KABADE RAHUL SANJAY	B.S.c.II	8999606708	R.S. Kabade
5	MALI VISHAL NETAJI	B.S.c.II	8262800292	V. Malhe
6	MASALAKAR CHAITNYA RAMESH	B.S.c.II	9607345729	SAR
7	SHINDE PRABHAT DNYANESHWAR	B.S.c.II	8208712749	S. B. Shinde.
8	NAGANE GAURAV SANJAY	B.S.c.II	7058281140	G.S. Nagane
9	SHINDE PRASHANT HANUMANT	B.S.c.II	8208404721	Prashant
10	MAHADIK SURAJ SHASHIKANT	B.S.c.II	9022997032	S. Mahadik.
11	SHIRSAT KARAN YASHWANT	B.S.c.II	8767742573	Karan
12	RAUT MANGESH DATTATRAYA	B.S.c.II	7498939306	M. Raut.

Caption Name:- BHOSALE RITESH VIJAYKUMAR.

R.S. Kabade



Madha Taluka Shikshan Prasarak Mandals

K.N.BHISE ARTS COMMERCE& VINAYAKRAO PATIL SCIENCE COLLEGE, BHOSARE.

Intra College Sport Competition Year: – 2022/2023.

Name of the Event: Cricket Men. Team Name: - **B.Sc. III** Date: 18-05-2023 to 21-05-2023.

Sr.No.	Name of the player	Class	Contact No	Signature
1	KAMBLE MAHESH SHYAMRAO	B.Sc.III	9158253884	<i>Kamble</i>
2	KHARE BALKRUSHNA VILAS	B.Sc.III	8766422837	<i>Khare</i>
3	MORE SANTOSH ABHIMAN	B.Sc.III	9175329062	<i>S.A. more</i>
4	PAWAR AMAR KHANDU	B.Sc.III	8767515642	<i>Amar</i>
5	NANDE SUDARSHAN NAVNATH	B.Sc.III	8180085848	<i>S. N. Nande</i>
6	MORE VISHAL NAVNATH	B.Sc.III	7796026994	<i>Vishal</i>
7	GARAD SUSHANT SUDHIR	B.Sc.III	9823649555	<i>Sushant</i>
8	MORE OM SHAHAJI	B.Sc.III	9561142155	<i>Om</i>
9	AWACHAR ROHIDAS SHIVAJI	B.Sc.III	9325694314	<i>Rohidas</i>
10	MISAL ANIKET PRAKASH	B.Sc.III	9561425318	<i>A. P. MISAL</i>
11	BARELA DILIP SONARYA	B.Sc.III	9673598632	<i>Barela</i>
12	KHARE BHARAT GAUTAM	B.Sc.III	9022042855	<i>Bharat</i>

Caption Name:- KAMBLE MAHESH SHYAMRAO.

Kamble



**K.N.BHISE ARTS, COMMERCE & V.PATIL SCIENCE
COLLEGE, BHOSARE**

Department of Physical Education & Sports

Final Result (Year -2022-23) Cricket – Men.

Sr.No.	Name of The Student	Class	Contact no	Position
1	MANDE SUMIT SUNIL	B.Com. III	8483893855	First Place
2	JAGTAP SHUBHAM MOHAN	B.Com. III	9096389472	
3	MOHITE VIJAY NAGNATH	B.Com. III	7972051819	
4	SAYYED NAWAZ MANSUR	B.Com. III	8600651494	
5	FARAD VINAY SOMNATH	B.Com. III	8421894977	
6	UBALE CHINTAMANEE BALASO	B.Com. III	7498750584	
7	PAWAR DHIRAJ UTTAM	B.Com. III	9307596928	
8	MULANI ARMAN MUNNA	B.Com. III	7498104886	
9	KALE ANAND LAXMAN	B.Com. III	9022371592	
10	PAWAR KIRAN ANIL	B.Com. III	9604053329	
11	SHAIKH ABDUL NISAR	B.Com. III	8180015175	
12	NIMBHORKAR DIPAK APPARAO	B.Com. III	7504529696	
Sr.No.	Name of The Student	Class	Contact no	Position
1	DHAGE DNYANESHWAR LAXMAN	BA.I	8010472906	Second Place
2	SONMUKHE NIKHIL NAGANATH	BA.I	8080916325	
3	THENGAL DASHRATH BABAN	BA.I	9075213069	
4	WAGH PRATHMESH SATISH	BA.I	8459959830	
5	SUKALE VIKAS SHANKAR	BA.I	8605982561	
6	BABAR SANDESH GOVARDHAN	BA.I	7620684486	
7	KHARE KARAN GAUTAM	BA.I	8806757935	

8	SALUNKE RAMDAS BAJIRAV	BA.I	9096892890	
9	SURVASE ABHIJIT TANAJI	BA.I	9022885376	
10	RAUT ABHISHEK SANTOSH	BA.I	8623085506	
11	SHINDE KALIDAS VASANT	BA.I	8275646421	
12	SURVE RAHUL DATTATRAYA	BA.I	9604403718	
Sr.No.	Name of The Student	Class	Contact no	Position
1	BHOSALE RITESH VIJAYKUMAR	B.S.c.II	7083845821	Third Place
2	RAUT PRAVIN MARUTI	B.S.c.II	9545652041	
3	KEDAR ROHIT ANKUSH	B.S.c.II	7768032749	
4	KABADE RAHUL SANJAY	B.S.c.II	8999606708	
5	MALI VISHAL NETAJI	B.S.c.II	8262800292	
6	MASALAKAR CHAITNYA RAMESH	B.S.c.II	9607345729	
7	SHINDE PRABHAT DNYANESHWAR	B.S.c.II	8208712749	
8	NAGANE GAURAV SANJAY	B.S.c.II	7058281140	
9	SHINDE PRASHANT HANUMANT	B.S.c.II	8208404721	
10	MAHADIK SURAJ SHASHIKANT	B.S.c.II	9022997032	
11	SHIRSAT KARAN YASHWANT	B.S.c.II	8767742573	
12	RAUT MANGESH DATTATRAYA	B.S.c.II	7498939306	



Madha Taluka Shikshan Prasarak Mandal's
**K. N. BHISE ARTS, COMMERCE AND VINAYAKRAO PATIL
SCIENCE COLLEGE, VIDYANAGAR, BHOSARE**

**Report of 100 Mts. Run. Competition
2022-23.**

Committee/ Department : Physical Education & Sports
Event : 100 mts. Run.
Date : 22/05/2023.
Venue : K. N. Bhise Arts, Commerce and Vinayakrao
Patil Science College, Bhosare.

Aims and Objectives:

1. To Create awareness about the sports and game.
2. To Promote Physical fitness.

Activities: In the academic year 2022-23, Gymkhana Department organized following activity.

Sr. No	Activity	Date	No. of Participants
1	100 mts. Run. (men /women)	22/05/2023	51

Support of Teaching and Non-Teaching Staff : All Staff members.

Outcomes:

1. The event promoted sports culture in the campus.
2. It created awareness about physical toughness and fitness.



I/c. Principal
**K.N. Bhise Arts, Commerce &
Vinayakrao Patil Science College**
Vidyanagar Bhosare, Dist-Solapur





100 mts. Run. (Women)



100 mts. Run. (Men)



Madha Taluka Shikshan Prasarak Mandals

K.N.BHISE ARTS COMMERCE& VINAYAKRAO PATIL SCIENCE COLLEGE, BHOSARE.

Intra College Sport Competition Year: – 2022/2023.

Name of the Event: 100 Mts. Run (All Faculties Men) Final Score Sheet Date: 22-05-2023.

Sr.No.	Name of the player	Class	Contact No	Final Timing	Position	Signature
1	LENDHE DIPAK INDRAJEET	BA.I	9922037118	15.07		
2	TONAPE SURAJ KISAN	B.Com.I	8007582055	16.10		
3	GAIKWAD PAVAN KUMAR	BA.I	8668634167	14.55		
4	SUKALE VIKAS SHANKAR	BA.I	8605982561	14.40		
5	PATIL ADESH SANTOSH	B.Com.I	9699473114	15.19		
6	DIKULE RANJIT PANDURANG	BA.I	8380935732	14.55		
7	ADSUL NILESH DATTA	B.Sc.I	9860704725	13.57		
8	GAIKWAD AJAY SUNIL	BA.I	7249036784	14.41		
9	ANANTKAVALAS SURESH HANUMANT	B.A.II	8262867946	13.55		
10	GADEKAR DHIRAJ SUHAS	B.Com.I	8180014352	15.20		
11	BORADE YASH GAJANAN	BA.I	9028889302	13.59		
12	AWACHAR AKSHAY ANGAD	B.A.II	8010351006	17.00		
13	PALASE AVDHUT HANUMANT	B.Com.II	8857917058	19.15	III rd	
14	SHELKE OMKAR LAXMAN	B.Com.II	8928601236	14.35		
15	BHOSALE AKASH JAGANNATH	B.A.III	7666457614	13.58		
16	CHAVAN AMOL VILAS	B.A.III	9529320933	14.12		
17	BAGAL RUSHIKESH KISHOR	B.A.II	9527295182	14.31		
18	CHAVAN DINESH SANJAY	B.A.II	7798026109	15.07		
19	BARADE SACHIN DILIP	B.Sc.I	9699006680	14.10		
20	KACHARE BALAJI ROHIDAS	B.A.II	8605603262	13.58		
21	AWATADE AMOL BANTU	B.Sc.II	7218404779	14.09		
22	DESHMUKH VINOD MAHADEO	B.Sc.II	8080239077	15.50		
23	JADHAV DHANAJI POPAT	B.A.III	9370690643	13.58		

24	MULANI SAJID HAJUALI	B.A.II	7666703722	14.07		S.h. mulani
25	GHADAGE SANKALP DHANAJI	B.A.III	9373616901	11.50	I st	Ghadage S.P.
26	BHONG NIKHIL PANDURANG	B.Sc.I	8010802161	14.08		Bhong N.P.
27	DABADE AJIT JOTIRAM	B.Sc.I	7499599907	14.01		A.J. Dabade.
28	AWACHAR ROHIDAS SHIVAJI	B.Sc.III	9325694314	12.85	II nd	Awachar
29	BARELA DILIP SONARYA	B.Sc.III	9673598632	15.01		Barela
30	RIKIBE SAGAR PARMESHWAR	B.Com.III	7522951414	13.59		Rikibe
31						
32						
33						
34						

Total 30 student present



Madha Taluka Shikshan Prasarak Mandals

K.N.BHISE ARTS COMMERCE & VINAYAKRAO PATIL SCIENCE COLLEGE, BHOSARE.

Intra College Sport Competition Year: – 2022/2023.

Name of the Event: 100 Mts. Run (All Faculties Women) Final Score Sheet Date: 22-05-2023.

Sr.No	Name of the player	Class	Contact No	Final Timing	Position	Signature
1	BAGAL GAURI DILIP	B.Sc.III	7875723329	14.20	III rd	C.B. Bagal
2	BAGAL ROHINI BIBHISHAN	B.Sc.III	9822969245	16.11		R.B. Bagal
3	SHAIKH JASMIN AMAR	B.Com.III	8177823586	17.00		J. Ashaith
4	TONAPE ARUNA RAJARAM	B.Sc.III	9881160513	15.15		A. Tona
5	BHOSALE RONIT SANTOSH	B.A.III	7758074962	16.48		
6	LANDGE RUTUJA CHANDRAKANT	B.Sc.III	9665193668	19.00		R.C. Landge
7	DHAVAL ANIRUDDHA AJITKUMAR	B.A.III	9359491690	21.00		A.A. Dhavale
8	JAGTAP ASHWINI BALU	B.A.III	9552696228	17.45		A.B. Jagtap
9	BHOSALE SUVARNA HANUMANT	B.Sc.III	9322707170	15.58		S.H. Bhosale
10	KAPARE RUTUJA SHIVAJI	B.Com.II	9921046833	16.12		R.S. Kapare
11	BAGWAN ARSIN SADIK	B.Sc.II	8856988794	15.10		Bagwan. a.s.
12	KHUNE NEHA DHANANJAY	B.Com.II	7385095531			N. Khune
13	PAWAR PAURNIMA AJAY	B.A.II	9075314024	14.11	II nd	P. Pawar
14	KADAM MAYURI VITTHAL	B.Com.II	8055963326	14.40		C. Kadam
15	CHAVAN DIVYA VITTHAL	B.Sc.II	9699200314	15.50		Chavan.D.V
16	NAVGIRE PRAJAKTA VASANT	B.A.II	9096892743	17.01		P. Navgire
17	SURVASE NAMRATA SHIVAJI	B.Com.III	8308469965	16.08		N. Survase
18	GANAGE VIDYA KRUSHNA	B.Sc.II	9325870792	15.12		G. Ganage
19	LONDHE SWAPNALI SAMADHAN	B.Com.II	8010830194	18.02		S. Londhe
20	KAMBLE BHAGYSHRI CHANGDEO	B.A.II	9763466850	14.05	I st	K. Kamble
21	BHAGYAVANT MOHINI BALIRAM	B.Sc.I	8799970617	17.44		Bhagyavant.M
22	DHORE SUPRIYA SURESH	B.Sc.I	9699335701	15.48		S.S. Dhore

total 22 student present



K.N.BHISE ARTS, COMMERCE & V.PATIL SCIENCE COLLEGE, BHOSARE					
Department of Physical Education & Sports					
Final Result (Year -2022-23).					
Sr.No.	Name of The Student	Class	Contact no	Performance	Position
Event - 100 mts Run (Men)					
1	GHADAGE SANKALP DHANAJI	B.A.III	9373616901	11.50	First
2	AWACHAR ROHIDAS SHIVAJI	B.Sc.III	9325694314	12.05	Second
3	PALASE AVDHUT HANUMANT	B.Com.II	8857917058	13.15	Third
Event - 100 mts Run (Women)					
1	KAMBLE BHAGYSHRI CHANGDEO	B.A.II	9763466850	14.05	First
2	PAWAR PAURNIMA AJAY	B.A.II	9075314024	14.11	Second
3	BAGAL GAURI DILIP	B.Sc.III	7875723329	14.20	Third



Madha Taluka Shikshan Prasarak Mandal's
**K. N. BHISE ARTS, COMMERCE AND VINAYAKRAO PATIL
SCIENCE COLLEGE, VIDYANAGAR, BHOSARE**

**Report of Long Jump Competition
2022-23**

Committee/ Department : Physical Education & Sports
Event : **Long Jump.**
Date : 22/05/2023.
Venue : K. N. Bhise Arts, Commerce and Vinayakrao
Patil Science College, Bhosare.

Aims and Objectives:

1. To Create awareness about the sports and game.
2. To Promote Physical fitness.

Activities: In the academic year 2022-23, Gymkhana Department organized following activity.

Sr. No	Activity	Date	No. of Participants
1	Long Jump. (men /women)	22/05/2023	40

Support of Teaching and Non-Teaching Staff : All Staff members.

Outcomes:

1. The event promoted sports culture in the campus.
2. It created awareness about physical toughness and fitness.



I/c.Principal
**K.N.Bhise Arts, Commerce &
Vinayakrao Patil Science College**
Vidyanagar Bhosare, Dist-Solapur



Long Jump (Men)



Long Jump (Women)



Madha Taluka Shikshan Prasarak Mandals

K.N.BHISE ARTS COMMERCE & VINAYAKRAO PATIL SCIENCE COLLEGE, BHOSARE.

Intra College Sport Competition Year: – 2022/2023.

Name of the Event: Long Jump (All Faculties Men) Final Score Sheet Date: 22-05-2023.

Sr. No.	Name of the player	Class	Contact No	1 Jump	2 Jump	3 Jump	Position	Signature
1	SUKALE VIKAS SHANKAR	BA.I	8605982561	F	4.80	F		
2	SONMUKHE NIKHIL NAGANATH	BA.I	8080916325	F	5.70	6.13	III rd	
3	UMBARKAR ABHIJEET SUBHASH	B.Com.I	9307856077	F	F	F		
4	GAIKWAD AJAY SUNIL	BA.I	7249036784	4.45	5.01	5.07		
5	KOTHMIRE ABHISHEK SANTOSH	B.Com.I	7410590629	F	F	5.10		Abhishek S.K
6	GUDEKAR GANESH VIJAY	B.Sc. I	9767946742	5.40	F	5.45		G. V. Gudekar
7	GORE SAURABH SHANKAR	BA.I	8262958848	5.40	4.91	5.20		S.S. Gore
8	SHINDE ROHAN SHIVAJI	B.A.II	8308781518	6.01	5.75	F		Shinde
9	LONDHE SANKET DNYANADEO	B.A.II	7028218485	5.10	5.47	F		Sanket
10	KADAM SARANG SANTOSH	B.Com.II	7666240360	4.50	F	4.47		Sarp
11	KASHID DATTATRYA SANJAY	B.Sc.I	9112946673	4.90	5.17	5.24		D. S. Kashid
12	YADAV PRATHAMESH NAGNATH	B.A.II	7083319702	6.08	6.10	F		AN Yadav
13	MARATHE NAGESH SIDDHU	B.Sc.I	7499477796	5.12	5.22	F		Arneesh
14	TONAPE GAURAV GOPAL	B.Com.II	9021375205	4.77	F	6.01		Tonape
15	KSHIRSAGAR OM RAJENDRA	B.Sc.II	9145376108	5.78	5.80	F		Om
16	GAVALI SURAJ ARJUN	B.A.III	9356517936	F	6.10	5.90		Ch Gavali
17	JAGTAP TUSHAR GAUTAM	B.A.III	9960863156	5.19	5.40	5.30		Gautam
18	JAGTAP TUSHAR GAUTAM	B.A.III	9960863156	—	—	—	—	—
19	PATOLE GANESH DNYANDEV	B.Sc.III	7249884055	3.90	F	4.20		G. Patole
20	THORAT MAHESH PANDURANG	B.Com.II	8669353692	F	4.80	F		M.P. Thorat
21	KHILARE SATYAVAN PARMESHWAR	B.A.III	9146676180	5.78	6.19	F	II nd	Khilare.s.p.

22	KHILARE NITIN PARMESHWAR	B.A.III	9607193895	5.30	6.55	6.61	Ist	N.P. Khilare
23	THORAT PRAVIN RAGHUNATH	B.Com.III	9604416155	5.11	F	4.90		R. Thorat
24								
25								

Total 22 student Present



Madha Taluka Shikshan Prasarak Mandals

K.N.BHISE ARTS COMMERCE & VINAYAKRAO PATIL SCIENCE COLLEGE, BHOSARE.

Intra College Sport Competition Year: – 2022/2023.

Name of the Event: **Long Jump (All Faculties Women)** Final Score Sheet Date: 22-05-2023.

Sr. No.	Name of the player	Class	Contact No	1 Jump	2 Jump	3 Jump	Position	Signature
1	INGALE TRUPTI APPASAHEB	B.A.III	7745025218	3.01	2.90	3.10		T.A. Ingale
2	JAGTAP NIKITA HANMANT	B.A.III	7796689441	2.50	F	F		A. Jagtap
3	SARVADE ASHWINI SHRIKANT	B.A.III	7020277658	3.40	4.01	4.20	III rd	A. Sarwade
4	LONDHE RUTIKA POPAT	B.S.c.II	8669556726	4.33	4.40	F		R.P. Londhe
5	NAVGIRE JAYSHREE HARIDAS	B.Com.III	9822645659	3.12	3.09	2.90		J.N. Navgire
6	UBALE ARATI SHARAD	B.Com.II	9860270973	4.01	3.78	F		A.S. Ubale
7	KALE VAISHNAVI RAMESH	B.S.c.II	8237836530	F	F	F		Kale. V.R.
8	GHODAKE NIKITA NAGNATH	BA.I	8010963036	2.22	F	2.01		N.N. Ghodake
9	RASAL PRAJAKTA ANIL	B.Com.III	9834877823	F	2.90	2.88		P.A. Rasal
10	MEHER NIKITA SUBHASH	B.Sc.III	8855031820	3.75	3.88	3.90		Nikita
11	PATIL SAKSHI TANAJI	BA.I	9403462999	4.15	4.10	F		S.T. Patil
12	TONAPE ARUNA RAJARAM	B.Sc.III	9881160513	4.11	3.89	4.07		A. Tonape
13	SALUNKE RUTUJA BHARAT	BA.I	9067272173	2.11	F	F		R.B. Salunke
14	LONDHE ROHAN SANTOSH	B.Sc.I	9960413072	2.95	F	3.10		B.
15	MEHER SAYLI SANJAY	B.Sc.I	7219305757	3.80	4.15	4.17		S.S. Meher
16	RATHOD PRAGATI GOPAL	B.Sc.I	8182081818	F	4.19	4.10		P. Rathod
17	KAMBLE BHAGYSHRI	B.A.II	9763466850	4.15	4.20	4.55	I st	B. Kamble
18	PAWAR PAURNIMA	B.A.II	9075314024	3.90	4.22	F	II nd	P. Pawar
19								
20								
21								
22								
23								

Total 18 student Present



K.N.BHISE ARTS, COMMERCE & V.PATIL SCIENCE COLLEGE, BHOSARE					
Department of Physical Education & Sports					
Final Result (Year -2022-23).					
Sr.No.	Name of The Student	Class	Contact no	Performance	Position
Event – Long Jump (Men)					
1	KHILARE NITIN PARMESHWAR	B.A.III	9607193895	6.61	First
2	KHILARE SATYAVAN PARMESHWAR	B.A.III	9146676180	6.19	Second
3	KHILARE SATYAVAN PARMESHWAR	B.A.III	9146676180	6.13	Third
Event – Long Jump (Women)					
1	KAMBLE BHAGYSHRI CHANGDEO	B.A.II	9763466850	4.55	First
2	PAWAR PAURNIMA AJAY	B.A.II	9075314024	4.22	Second
3	SARVADE ASHWINI SHRIKANT	B.A.III	7020277658	4.20	Third



Madha Taluka Shikshan Prasarak Mandal's
**K. N. BHISE ARTS, COMMERCE AND VINAYAKRAO PATIL
SCIENCE COLLEGE, VIDYANAGAR, BHOSARE**

Report of Shoot Put Throw Competition

2022-23.

Committee/ Department : Physical Education & Sports
Event : Shoot Put Throw
Date : 22/05/2023.
Venue : K. N. Bhise Arts, Commerce and Vinayakrao
Patil Science College, Bhosare

Aims and Objectives:

1. To Create awareness about the sports and game.
2. To Promote Physical fitness.

Activities: In the academic year **2022-23**, Gymkhana Department organized following activity.

Sr. No	Activity	Date	No. of Participants
1	Shoot Put Throw. (men /women)	22/05/2023	41

Support of Teaching and Non-Teaching Staff : All Staff members.

Outcomes:

1. The event promoted sports culture in the campus.
2. It created awareness about physical toughness and fitness.



I/c.Principal
**K.N.Bhise Arts, Commerce &
Vinayakrao Patil Science College**
Vidyanagar Bhosare, Dist-Solapur



Shoot Put Throw (Men)



Shoot Put Throw (Women)



Madha Taluka Shikshan Prasarak Mandals

K.N.BHISE ARTS COMMERCE & VINAYAKRAO PATIL SCIENCE COLLEGE, BHOSARE.

Intra College Sport Competition Year: – 2022/2023.

Name of the Event: **Shoot Put Throw (All Faculties Men)** Final Score Sheet Date: 22-05-2023.

Sr. No.	Name of the player	Class	Contact No	1 Throw	2 Throw	3 Throw	Position	Signature
1	LENDHE DIPAK INDRAJEET	BA.I	9922037118	7.14	6.99	7.15		
2	JADHAV DHANAJI POPAT	B.A.III	9370690643	6.00	6.12	F		
3	MULANI SAJID HAJUALI	B.A.II	7666703722	F	F	7.30		
4	REDE ADITYA SHAHAJI BHOSALE VIJAY	B.A.II B.A.II	7796347102 753306905	8.15	9.10	9.08		
5	REDE ADITYA SHAHAJI	BA.I	7709078477	8.10	7.90	F		
6	KEDAR ANIKET RAMLING	B.Sc.II	8698042516	5.01	F	F		
7	GAIKWAD AJAY SUNIL	BA.I	7249036784	9.10	10.11	F		
8	BAGAL OM ANANTRAO	BA.I	9145221109	12.90	11.00	11.40	I st	
9	PATIL ADESH SANTOSH	B.Com.I	9699473114	7.13	8.19	F		
10	CHAVAN AMOL VILAS	B.A.III	9529320933	10.12	11.13	12.01	II nd	
11	PATIL SHIVRATNA MAHADEV	B.Com.I	9881793077	F	9.47	9.42		
12	BHOSALE DNYANESHWAR BABAN	BA.I	9552021765	11.03	F	10.90	III rd	
13	GADE VIKRAM RAMRAO	B.Sc.I	9322491843	F	F	7.40		
14	GOPHANE MOHAN SARJERAO	B.Sc.I	9075323432	10.04	9.88	F		
15	KALE SAMARTH SURESH	B.Sc.I	7820831949	F	F	6.70		
16	AWAGHADE SUMIT BALASAHEB	B.A.II	9637126484	9.40	8.80	9.10		
17	JADHAV SANJAY HANUMANT	B.A.II	7796498082	7.30	6.90	F		
18	FARAD PRASHANT POPAT	B.A.II	7774067607	F	8.81	10.12		
19	GORE SAGAR MAHESH	B.Com.II	7972533703	10.13	11.02	F		
20	CHANDANE TEJAS SHAHAJI	B.Com.II	9158576480	8.90	8.81	9.01		
21	DESHMUKH VINOD MAHADEO	B.Sc.II	8080239077	9.13	9.80	10.01		

22	KAPARE AMAR SUBHASH	B.A.II	9604767459	7.80	7.50	F		Amar
23	GAVHANE SAURABH SOMNATH	B.A.III	8380849190	F	9.40	8.90		Saurabh
24	SATAV GANESH MARUTI	B.A.III	7798113006	9.80	10.10	F		Sata
25								
26								
27								
28								

Total 24 student Present.

Suf
Prof. B. R. Shetty



K.N.BHISE ARTS, COMMERCE & V.PATIL SCIENCE COLLEGE, BHOSARE					
Department of Physical Education & Sports					
Final Result (Year -202-23).					
Sr.No.	Name of The Student	Class	Contact no	Performance	Position
Event – Shoot Put Throw (Men)					
1	BAGAL OM ANANTRAO	BA.I	9145221109	12.90	First
2	CHAVAN AMOL VILAS	B.A.III	9529320933	12.01	Second
3	BHOSALE DNYANESHWAR BABAN	BA.I	9552021765	11.03	Third
Event – Shoot Put Throw (Women)					
1	TALEKAR PRAGATI VASANT	B.A.II	8459031589	9.10	First
2	KAMBLE BHAGYSHRI CHANGDEO	B.A.II	9763466850	8.90	Second
3	SARWADE SNEHAL DATTATRAY	B.Com.III	9579056355	8.81	Third



Madha Taluka Shikshan Prasarak Mandal's
**K. N. BHISE ARTS, COMMERCE AND VINAYAKRAO PATIL
SCIENCE COLLEGE, VIDYANAGAR, BHOSARE**

Report of Badminton Competition

2022-23.

Committee/ Department : Physical Education & Sports
Event : Badminton (Men/Women).
Date : 23/05/2023
Venue : K. N. Bhise Arts, Commerce anVinayakrao Patil
Science College, Bhosare

Aims and Objectives:

1. To Create awareness about the sports and game.
2. To Promote Physical fitness.

Activities: In the academic year **2022-23**, Gymkhana Department organized following activity.

Sr. No	Activity	Date	No. of Participants
1	Badminton (men/Women)	22/05/2023	34

Support of Teaching and Non-Teaching Staff : All Staff members.

Outcomes:

1. The event promoted sports culture in the campus.
2. It created awareness about physical toughness and fitness.



I/c.Principal
**K.N.Bhise Arts,Commerce &
Vinayakrao Patil Science College
Vidyanagar Bhosare,Dist-Solapur**



Badminton Competition



Badminton Competition





GPS Map Camera



Kurduvadi, Maharashtra, India
4C2M+VPJ, SH161, Near K.N.Bhishe Collage, Kurduvadi, Maharashtra 413208, India
Lat 18.102538°
Long 75.435293°
23/05/23 10:30 AM GMT +05:30

Badminton Competition

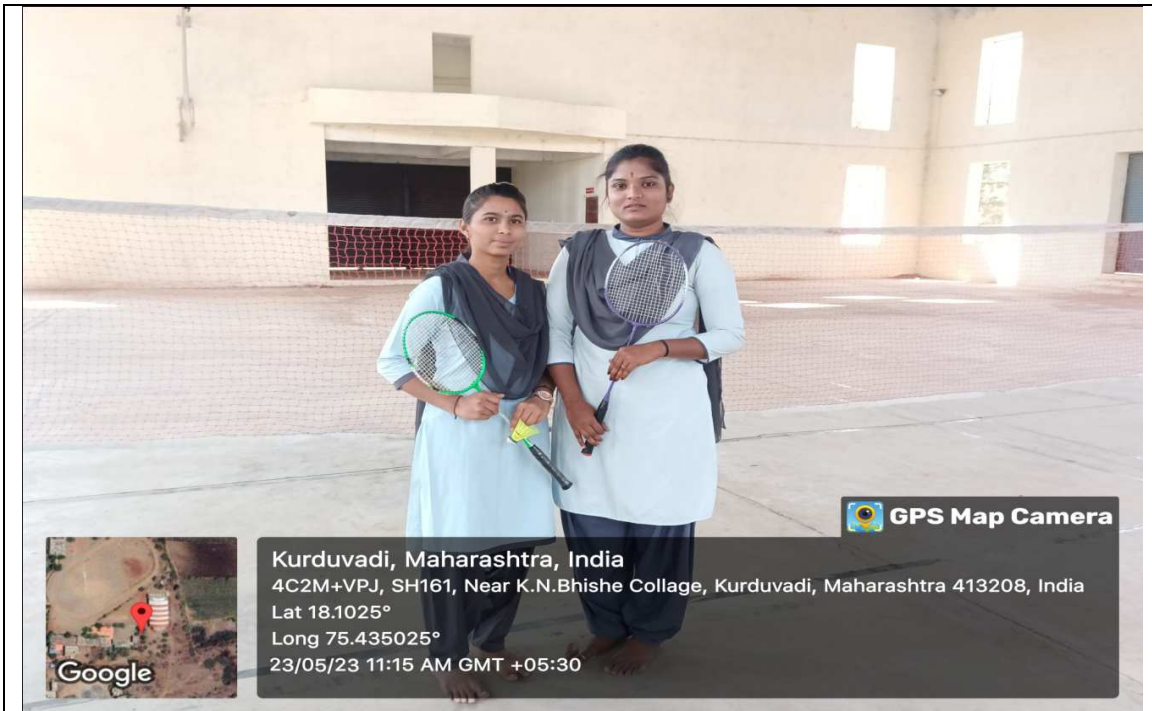

GPS Map Camera



Kurduvadi, Maharashtra, India
4C2M+VPJ, SH161, Near K.N.Bhishe Collage, Kurduvadi, Maharashtra 413208, India
Lat 18.1025°
Long 75.435025°
23/05/23 11:15 AM GMT +05:30

Badminton Competition



Intra College Sport Competition Year: – 2022/2023.

Name of the Event: **Badminton (Men)** Date: 18-05-2023.

Lots

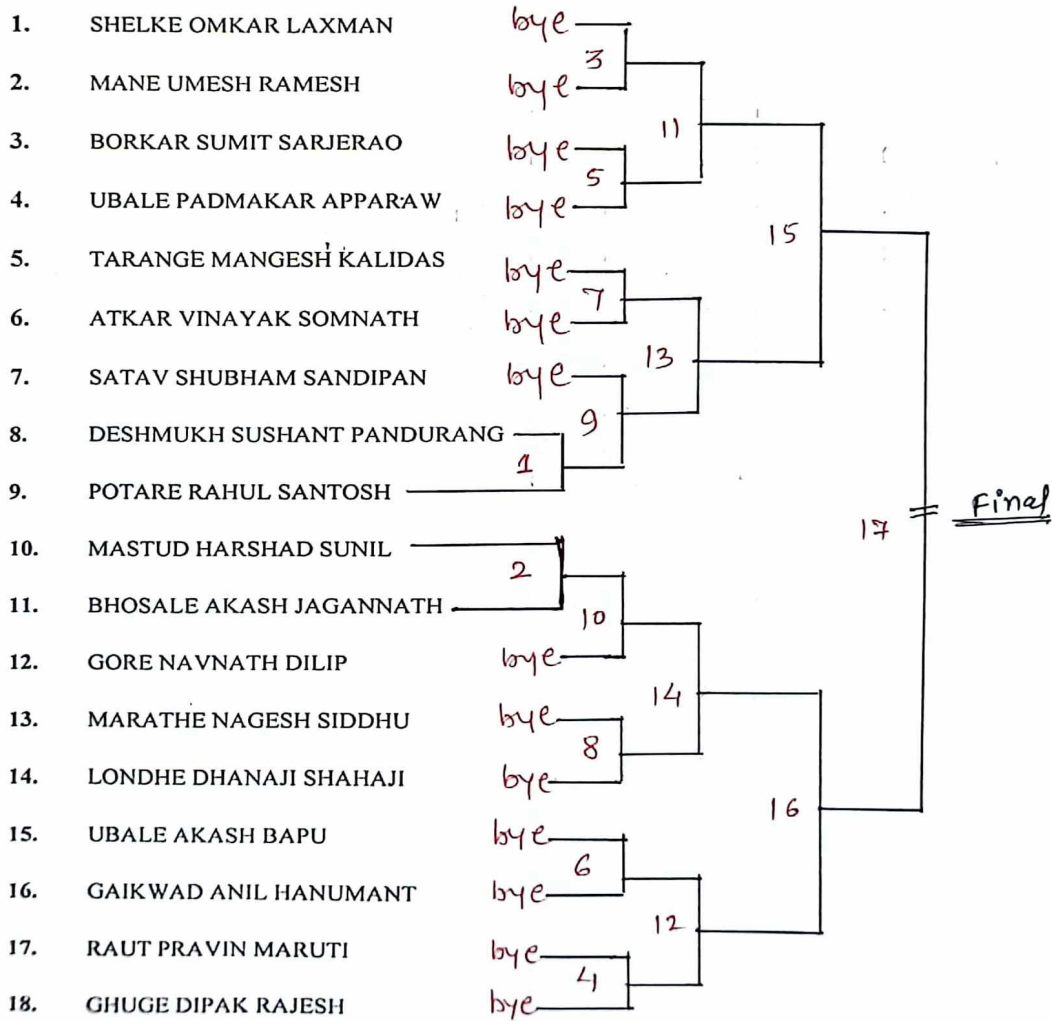

Amkhar

Atkar M. A.B. Ubalc.

Amkhar

Sushant Omkar

Harshad

M.K. Tarange. P.A. Ubalc.

Prof. Goyal A.M - Amkhar

Madhu Taluka Shikshan Prasarak Mandals

K.N.BHISE ARTS COMMERCE & VINAYAKRAO PATIL SCIENCE COLLEGE, BHOSARE.

Intra College Sport Competition Year: – 2022/2023.

Name of the Event: **Badminton (Men)** Eligibility / Final List.

Date: 23-05-2023.

Sr.No.	Name of the player	Class	Contact no	Signature
1	BHOSALE AKASH JAGANNATH	B.A.III	7666457614	A. J. Bhosale
2	GAIKWAD ANIL HANUMANT	B.Com.III	8975250669	Anil Gaiwad
3	ATKAR VINAYAK SOMNATH	B.Com.II	9370186003	Atkar
4	DESHMUKH SUSHANT PANDURANG	B.Com.III	9730609677	Sushant
5	GORE NAVNATH DILIP	B.Com. III	7709986930	Nath
6	BORKAR SUMIT SARJERAO	B.A.III	9657683469	Sumit
7	RAUT PRAVIN MARUTI	B.S.c.II	9545652041	Raut.P.M
8	SATAV SHUBHAM SANDIPAN	B.S.c.II	9172457893	Sata
9	UBALE AKASH BAPU	B.S.c.II	7058180526	A. R. Ubale.
10	SHELKE OMKAR LAXMAN	B.Com.II	8928601236	Omkar
11	MASTUD HARSHAD SUNIL	B.A.II	7517665101	Harshad
12	GHUGE DIPAK RAJESH	B.A.III	7499754329	Dipak
13	POTARE RAHUL SANTOSH	B.A.II	9420436055	Rahul
14	LONDHE DHANAJI SHAHAJI	B.Sc.I	9579540056	Dhanaji
15	MANE UMESH RAMESH	B.Sc.I	9309893558	Umesh
16	MARATHE NAGESH SIDDHU	B.Sc. I	7499477796	Nagesh
17	TARANGE MANGESH KALIDAS	B.Sc.I	8308693391	M.K. Tarange
18	UBALE PADMAKAR APPARAW	B.Com.I	9322352223	P.A. Ubale.
19				
20				
21				
22				



Madha Taluka Shikshan Prasarak Mandals

K.N.BHISE ARTS COMMERCE & VINAYAKRAO PATIL SCIENCE COLLEGE, BHOSARE.

Intra College Sport Competition Year: – 2022/2023.

Name of the Event: **Badminton (Women)** Date: 18-05-2023.

Lots

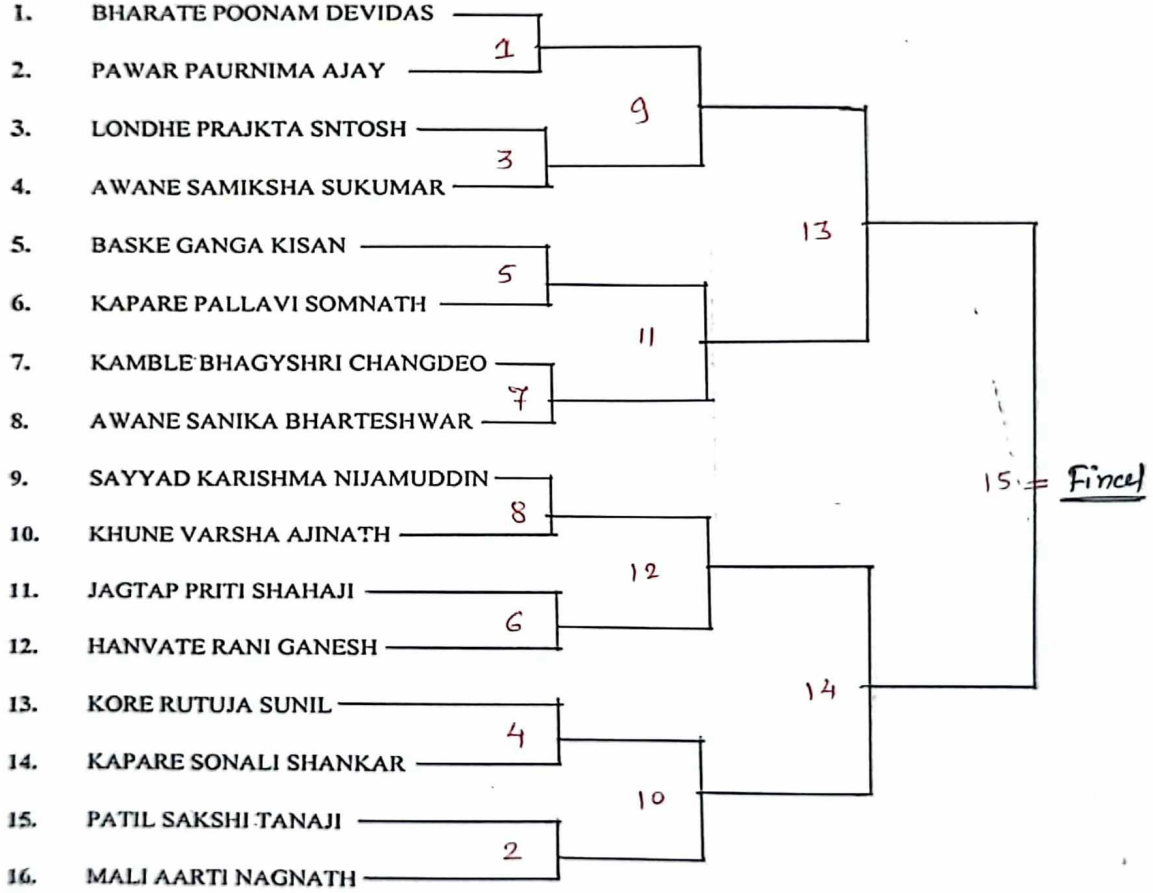

S.S. Kapare

S.S. KAPARE



P.S. Jagtap

V.A. Khune

R.S. Kore S.S. Awane

Sayyad

Prof. Goyal A.M – Alam

Bell

Madhu Taluka Shikshan Prasarak Mandals

K.N.BHISE ARTS COMMERCE & VINAYAKRAO PATIL SCIENCE COLLEGE, BHOSARE.

Intra College Sport Competition Year: – 2022/2023.

Name of the Event: **Badminton (Women)** Eligibility / Final List.

Date: 23-05-2023.

Sr.No.	Name of the player	Class	Contact no	Signature
1	BASKE GANGA KISAN	B.Com.I	9673948330	G. K. Baske
2	PATIL SAKSHI TANAJI	BA.I	9403462999	S. T. Patil
3	JAGTAP PRITI SHAHAJI	B.Com.I	7517563093	P. S. Jagtap
4	MALI AARTI NAGNATH	B.Sc. I	8793803540	Aarti
5	BHARATE POONAM DEVIDAS	BA.I	9011962094	P. D. Bharate
6	KAPARE SONALI SHANKAR	B.Com.II	7447616270	S. S. KAPARE
7	HANVATE RANI GANESH	BA.I	8975931380	R. G. Hanvate
8	AWANE SAMIKSHA SUKUMAR	B.Com.I	8767191275	S. S. Awane
9	AWANE SANIKA BHARTESHWAR	B.Com.I	9763144555	S. B. Awane
10	KHUNE VARSHA AJINATH	B.A.II	9067275075	V. A. Khune
11	PAWAR PAURNIMA AJAY	B.A.II	9075314024	P. Pawar
12	KAMBLE BHAGYSHRI CHANGDEO	B.A.II	9763466850	B. Kamble
13	KORE RUTUJA SUNIL	B.A.II	9172340773	R. S. Kore
14	LONDHE PRAJKTA SNTOSH	B.A.II	9422483513	P. Londhe
15	SAYYAD KARISHMA NIJAMUDDIN	B.Com.II	8767384470	K. Sayyad
16	KAPARE PALLAVI SOMNATH	B.Sc.I	9850334758	P. Kapare
17				
18				
19				
20				
21				
22				



माढा तालुका शिक्षण प्रसारक मंडळ संचालित

के. एन. भिसे आर्ट्स, कॉमर्स अँड विनायकराव पाटील सायन्स कॉलेज
विद्यानगर, भोसरे

नोटिस

वरिष्ठ महाविद्यालयातील मधील सर्व प्राध्यापक/ प्राध्यापिका, Non – teaching स्टाफ यांना कळविण्यात येते की २०२२-२३ या शैक्षणिक वर्षी, विद्यार्थ्यांच्या कला गुणांना वाव देण्यासाठी महाविद्यालयत विविध सांस्कृतिक कार्यक्रम १७/०४/२०२३ पासून आयोजित केले आहे. तरी सर्व प्राध्यापक/ प्राध्यापिकानी जास्तीतजास्त विद्यार्थी कार्यक्रमात सहभागी होतील याची दक्षता घ्यावी व सांस्कृतिक विभागस योगदान द्यावे.

कार्यक्रमाची यादी खालील प्रमाणे :

Sr. No	Date	Event	Committee Members	Judges of the Events
1	17/04/2023	Inaugration Function	Mr. A. M. Goyal Mr. B. R. Shejul Dr. V. B. Waghmare Dr. N. D. Deshmukh Mr. D. B. Jadhav Dr. M. N. Salunkhe Madam Dr. S. V. Mohite Madam	-
2	17/04/2023	A. रंगोळी स्पर्धा B. निबंध स्पर्धा C. काव्य लेखन	Dr. M. N. Salunkhe Madam Dr. S. V. Mohite Madam Dr. A. P. Pol Madam Dr. Jadhav S. J. Madam	Dr. Pol A.P Madam Miss. Shinde V. S.
3	18/04/2023	Trade Festival एक पात्री नाटक	Dr. V. B. Waghmare Mr. P. K. Narkhade	Dr. Londhe S. V.









		पथ नाट्य	Mr. A. M. Goyal Mr. Pantulwar R. G. Dr. M. N. Salunkhe Madam Dr. S. V. Mohite Madam	Mr. Goyal A. M.
4	19/04/2023	A. वक्तृत्व स्पर्धा B. वाद विवाद	Mr. B. R. Shejul Dr. V. B. Waghmare Mr. P. K. Narkhade Mr. A. M. Goyal Dr. Nagare V. B.	I/C Prin. Dr. Kamble P. S. Dr. Deshmukh N. D.
5	20/04/2023	A. Fancy Dress Competition B. मिमिक्रि स्पर्धा	Dr. N. D. Deshmukh Mr. A. M. Goyal Dr. M. N. Salunkhe Madam Mr. B. R. Shejul Dr. A. M. More	Miss. Jadhav S. J. Dr. Kshirsagar S. S.
6	21/04/2023	A. Miss match Day Competition B. Nature Photography	Mr. A. M. Goyal Mr. B. R. Shejul Dr. V. B. Waghmare Dr. Deshmukh N. D Dr. Kadam A. H Mr. Shinde V. S.	Mr. Patil M. M Mr. Phulwale S. P.
7	24/04/2023	A. Traditional Day Competition B. Tie and Sari Day	Mr. A. M. Goyal Mr. B. R. Shejul Dr. V. B. Waghmare Dr. N. D. Deshmukh Dr. Tambile P. I. Mr. Jadhav, D. B. Dr. M. N. Salunkhe Madam Dr. S. V. Mohite Madam	Dr. Londhe S. V. Dr. Kadam A. H
8	24/04/2023	Prize Distribution Ceremony	Dr. V. B. Waghmare Dr. N. D. Deshmukh Mr. A. M. Goyal Mr. B. R. Shejul Dr. Tambile P. I. Dr. M. N. Salunkhe Madam	

			Dr. S. V. Mohite Madam Mr. S. P. Phulwale
9.		सर्व कार्यक्रमासाठी Non - teaching staff	Mr. Nawale Vaibhav Mr. Dhumal Vikas Mr. Kamble Dada

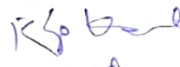
Note :-

- 1) All the programs will start at 10.00 am on respective day.
- 2) All the committee member of the event are responsible for event success.
- 3) All the faculties should take efforts for maximum participation of the students.
- 4) Program time will be 10.00 to 11.30, No lectures should be held at this time and all faculties with students should be present in the cultural hall.
- 5) All the faculties should take efforts to maintain discipline in the hall by the students.
- 6) Non-teaching staff should open the hall and arrange the chairs, Mic system before time.

Staff Signature

- 1) Goyal A.M. 
- 2) B.R. Shejwani 
- 3) Dr. R.G. Pantulwar 
- 4) M.M. Patil - 
- 5) S.P. Phulwale - 
- 6) Dr. V.B. Waghmare 
- 7) Mrs. V.S. Shinde 
- 8) Dr. Mohite S.V. 
- 9) Dr. A.P. Patil 

 i/c. Principal
 K.N. Bhise Arts, Commerce &
 Vinayakrao Patil Science College
 Vidyanagar Bhosare, Dist-Solapur

Annual Cultural Activity Report 2022- 2023

Name of the Department/ Committee	: Cultural Department.
Activity Report Year	: 2022-23
Events	: Various Competition
Date	: 17/04/2023 to 24/04/2023

Aims and Objectives :

To give all the students opportunity to be involved in culturally enriching activities and competitions.

To identify the students with special talent in the cultural activities.

To groom their area of expertise and enhance their capabilities in such activities.

Help the today's students to convert in to confident, talented and fearless adults of tomorrow's society.

Committee organized the following activities in the academic year 2022-23

Sr. No	Name of Activity	No. of Participants	Date
1	Rangoli Competition	12	17/04/2023
2	Essay Competition	35	17/04/2023
3	Poetry (Kavya Vachan/Lekhan) Competition	08	17/04/2023
4	Trade festival and competition	27	18/04/2023
5	Debate Competition	20	19/04/2023

Madha Taluka Shikshan Prasarak Mandal's
K N. Bhise Arts, Commerce and Vinayakrao Patil Science
College, Vidyanagar, Bhosare

Paranda Road, Kurduwadi, Tal- Madha, Dist Solapur Pin- 413208 (Maharashtra)

NAAC 'A' Grade (3.10 CGPA)

6	Elocution Competition	06	19/04/2023
7	Fancy Dress Competition	11	20/04/2023
8	Miss Match dress Competition	09	21/04/2023
9	Nature Photography Competition	22	21/04/2023
10	Traditional Dress Competition	18	24/04/2023

Support / Assistance: Cultural Committee Members, All teaching and Non – teaching staff of the college.

Outcomes of Activites :

- Students skills were enhanced.
- Their stage daring increased tremendously.
- They became more self-confident.
- They became more alert towards time – management.
- More and more students get attracted towards enhancing their talents and present them in front of audience.



I/c.Principal
K.N.Bhise Arts,Commerce &
Vinayakrao Patil Science College
Vidyanagar Bhosare,Dist-Solapur

Madha Taluka Shikshan Prasarak Mandal's
K N. Bhise Arts, Commerce and Vinayakrao Patil Science
College, Vidyanagar, Bhosare
Paranda Road, Kurduwadi, Tal- Madha, Dist Solapur Pin- 413208 (Maharashtra)

NAAC 'A' Grade (3.10 CGPA)

Activity Report

Name of the Department/ Committee : **Cultural Department.**

Activity Report Year : **2022-23**

Name of the activity : **Rangoli competition**

Date		Department	Coordinator Name
17-04-2023		Cultural	Dr. Salunkhe M. N. Dr. Mohite S. V.
Time	Venue	Activity for the class/ group	Nature of the activity
From 10.00am onwards	Arts Building	All faculties	Competition

Support/ Assistance: Cultural Committee Members

General information of the activity

Topic of the Activity	Competition : To Make Rangoli on given Topic in given time.
Objective	To create awareness among the students about the Environment issues and enhance their skills in day to day art like Rangoli.
Methodology	Students have to visualise, draw and represent their idea with the help of Rangoli making.
Outcome	Students got the platform to express their view, enhance their skills and overall Personality development.
Participants No.	12

Madha Taluka Shikshan Prasarak Mandal's
K N. Bhise Arts, Commerce and Vinayakrao Patil Science
College, Vidyanagar, Bhosare
Paranda Road, Kurduwadi, Tal- Madha, Dist Solapur Pin- 413208 (Maharashtra)

NAAC 'A' Grade (3.10 CGPA)

Madha Taluka Shikshan Prasarak Mandal's
K N. Bhise Arts, Commerce and Vinayakrao Patil Science
College, Vidyanagar, Bhosare
Paranda Road, Kurduwadi, Tal- Madha, Dist Solapur Pin- 413208 (Maharashtra)

NAAC 'A' Grade (3.10 CGPA)



Proofs attached:

1. Notice	2. Photos
3. Student Participant List	4. Student Attendance list
5. Results	

Results : Rangoli Competition

Position	Name of the student	Class
First Prize	Mr. Keshav Sanjay Chavan	S.Y.B.Sc
Second Prize	Ms. Jyotsna Rajendra Dabade	T.Y.B.Sc
Third Prize	Ms. Subhangi Satish wagh	T.Y.B.Sc T.Y.B.Sc

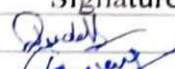
Faculty Judges :

Sr. No	Faculty Name	Signature
1	Prof. Ms. Shinde V. S.	
2	Prof Ms. Jadhav S. J.	

I/c. Principal
K.N.Bhise Arts, Commerce &
Vinayakrao Patil Science College
Vidyanagar Bhosare, Dist-Solapur

Madha Taluka Shikshan Prasarak Mandal's
**K N. Bhise Arts, Commerce and Vinayakrao Patil Science
College, Vidyanagar, Bhosare**

Paranda Road, Kurduwadi, Tal- Madha, Dist Solapur Pin- 413208 (Maharashtra)

NAAC 'A' Grade (3.10 CGPA)

Rangoli Competition 17/04/2023



Madha Taluka Shikshan Prasarak Mandal's
K. N. Bhise Arts, Commerce and Vinayakrao Patil Science
College, Vidyanagar, Bhosare

Paranda Road, Kurduwadi, Tal- Madha, Dist Solapur Pin- 413208 (Maharashtra)

NAAC 'A' Grade (3.10 CGPA)

Madha Taluka Shikshan Prasarak Mandal's
K. N. Bhise Arts, Commerce and Vinayakrao Patil Science College
Vidyanagar, Bhosare.

Cultural Department

Name of the Activity :- Rangoli Competition Participation List
Year- 2022 - 2023

Sr. No	Mob No	Name of Student	Class	Signature
1		A.R. Dhavane	B.No. II	A.R. Dhavane
2	8010451011	Jyotsna Dabade	B.com I	J.R. Dabade
3	9975858915	Kumbhar Snehal	B.com. I	S.V. Kumbhar
4	9925093799	Om Mithare	B.com. I	Om. Mithare
5	9579448409	Vivekanand Chate	B.com. I	V.V. Chate
6	8459952405	Wagh Shubhangi	B.sc - III	S. Wagh
7	8788272881	Godge Aaditi	B.sc III	Aaditi Godge
8	7219867195	Shruti Mali	B.sc. I	S. Mali
9	99605050198194	Puja Gavali	B.sc. I	P. Gavali
10	7038263383	Meghna Kabade	B.sc. I	M. Kabade
11	8390584202	Chetan Keshav	B.sc. II	C. Keshav
12	9503982411	Shirani bagal	B.sc III	S. Bagal
13				
14				
15				
16				
17				
18				
19				
20				
21				
22				
23				
24				
25				
26				
27				
28				
29				
30				
31				
32				
33				

I/c. Principal
K. N. Bhise Arts, Commerce &
Vinayakrao Patil Science College
Vidyanagar Bhosare, Dist-Solapur

Madha Taluka Shikshan Prasarak Mandal's
K N. Bhise Arts, Commerce and Vinayakrao Patil Science
College, Vidyanagar, Bhosare
Paranda Road, Kurduwadi, Tal- Madha, Dist Solapur Pin- 413208 (Maharashtra)

NAAC 'A' Grade (3.10 CGPA)

Activity Report

Name of the Department/ Committee : **Cultural Department.**

Activity Report Year : **2022-23**

Name of the activity : **Poetry Competition**

Date		Department	Coordinator Name
17-04-2023		Cultural	Dr. Salunkhe M. N. Dr. Mohite S. V.
Time	Venue	Activity for the class/ group	Nature of the activity
From 10.00 am onwards	Seminar Hall	All faculties	Competition

Support/ Assistance: Cultural Committee Members

General information of the activity

Topic of the Activity	Only Self Made Poetry can be submitted
-----------------------	--

Objective	To Enhance the skills of all the faculty students towards poetry
Methodology	Students have to write a poetry on their own and express it in front of audience.
Outcome	Students got the platform to express their view, enhance their skills and overall Personality development.
Participants No.	08

Proofs attached:

1. Notice	2. Photos
3. Student Participant List	4. Student Attendance list
5. Results	

Madha Taluka Shikshan Prasarak Mandal's
K N. Bhise Arts, Commerce and Vinayakrao Patil Science
College, Vidyanagar, Bhosare

Paranda Road, Kurduwadi, Tal- Madha, Dist Solapur Pin- 413208 (Maharashtra)

NAAC 'A' Grade (3.10 CGPA)



Madha Taluka Shikshan Prasarak Mandal's
K N. Bhise Arts, Commerce and Vinayakrao Patil Science
College, Vidyanagar, Bhosare
Paranda Road, Kurduwadi, Tal- Madha, Dist Solapur Pin- 413208 (Maharashtra)

NAAC 'A' Grade (3.10 CGPA)

Results : Poetry (काव्यवाचन /काव्यलेखन) Competition

Position	Name of the student	Class
First Prize	Mr. Bongale Kishor	T.Y.B.Sc
Second Prize	Ms. Lambatkar Mayuri	F.Y.B.A
Third Prize	Mr. Kamble Mahesh	T.Y.B.Sc

Faculty Judges :

Sr. No	Faculty Name	Signature
1	Prof. Ms. Shinde V. S.	
2	Prof Ms. Jadhav S. J.	

I/c. Principal
K.N.Bhise Arts, Commerce &
Vinayakrao Patil Science College
Vidyanagar Bhosare, Dist-Solapur

Madha Taluka Shikshan Prasarak Mandal's
**K N. Bhise Arts, Commerce and Vinayakrao Patil Science
College, Vidyanagar, Bhosare**
Paranda Road, Kurduwadi, Tal- Madha, Dist Solapur Pin- 413208 (Maharashtra)

NAAC 'A' Grade (3.10 CGPA)



Kavya vachan / Poetry Competition 17/04/2023



Madha Taluka Shikshan Prasarak Mandal's
K N. Bhise Arts, Commerce and Vinayakrao Patil Science
College, Vidyanagar, Bhosare

Paranda Road, Kurduwadi, Tal- Madha, Dist Solapur Pin- 413208 (Maharashtra)

NAAC 'A' Grade (3.10 CGPA)

Madha Taluka Shikshan Prasarak Mandal's
K. N. Bhise Arts, Commerce and Vinayakrao Patil Science College
Vidyanagar, Bhosare.

Cultural Department

Name of the Activity -: **Kavya Vachan Competition Participation List**
Year- 2022 - 2023

Sr. No	Mag. PRN No	Name of Student	Class	Signature
1		Ankita bhavale	B.A.II	A.P. bhavale
2		Amruta Bagal	B.A.II	Amruta Bagal
3	9604117361	Lambhakar Mayuri	B.A.-I	M.A. Lambhakar
4	93252992109	Om Anvishant Mittal	B.COM I	O.A. Mittal
5	9158253884	Kamble mahesh	BSC.FE	K.A.
6	9607195529	Bangale kishor	BSC.III	K.A.
7	7709507137	Bagal sakshi	B.SC-III	Bagal.
8		श्री. र. र. उ. र. र.	B. SC	
9				
10				
11				
12				
13				
14				
15				
16				
17				
18				
19				
20				
21				
22				
23				
24				
25				
26				
27				
28				
29				
30				
31				
32				
33				

I/c. Principal
K.N. Bhise Arts, Commerce &
Vinayakrao Patil Science College
Vidyanagar Bhosare, Dist-Solapur

Madha Taluka Shikshan Prasarak Mandal's
K N. Bhise Arts, Commerce and Vinayakrao Patil Science
College, Vidyanagar, Bhosare

Paranda Road, Kurduwadi, Tal- Madha, Dist Solapur Pin- 413208 (Maharashtra)

NAAC 'A' Grade (3.10 CGPA)

Activity Report

Name of the Department/ Committee : **Cultural Department.**

Activity Report Year : **2022-23**

Name of the activity : **Essay competition**

Date		Department	Coordinator Name
17-04-2023		Cultural	Dr. Mohite S. V. Dr. Salunkhe M. N.
Time	Venue	Activity for the class/ group	Nature of the activity
From 10.00am onwards	Seminar Hall	All faculties	Competition

Support/ Assistance: Cultural Committee Members

General information of the activity

Topic of the Activity	1) New Education Policy/ नवीन शैक्षणिक धोरणाचे फायदे तोटे. 2) पुस्तक : एक हरवलेला मित्र 3) पर्यावरण संवर्धन : काळाची गरज 4) रासायनिक का सेंद्रिय शेती 5) महागाई : समस्या की संधी
-----------------------	--

Objective	To create awareness among the students of the Current topics of India and enhance their skills in expressing their views in written form.
Methodology	Students have to visualise, Express and represent their idea in an Essay form.
Outcome	Students got the platform to express their

Madha Taluka Shikshan Prasarak Mandal's
K N. Bhise Arts, Commerce and Vinayakrao Patil Science
College, Vidyanagar, Bhosare

Paranda Road, Kurduwadi, Tal- Madha, Dist Solapur Pin- 413208 (Maharashtra)

NAAC 'A' Grade (3.10 CGPA)

Madha Taluka Shikshan Prasarak Mandal's
K N. Bhise Arts, Commerce and Vinayakrao Patil Science
College, Vidyanagar, Bhosare
Paranda Road, Kurduwadi, Tal- Madha, Dist Solapur Pin- 413208 (Maharashtra)

NAAC 'A' Grade (3.10 CGPA)

	view, enhance their skills and overall Personality development.
Participants No.	35



Proofs attached:

1. Notice	2. Photos
3. Student Participant List	4. Student Attendance list
5. Results	

Results : Rangoli Competition

Position	Name of the student	Class
First Prize	Ms. Kumbhar Snehal Vishnu	F.Y.B.Com
Second Prize	Ms. Gavali Pooja Dnyandev	F.Y.B.Sc
Third Prize	Ms. Anantkawalas Sanika Arjun Ms. Kabade Meghna Sudhir	F.Y.B.Sc F.Y.B.Sc

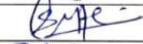
Faculty Judges :

Sr. No	Faculty Name	Signature
1	Prof. Dr. Pol A. P.	
2	Prof. Dr. Mohite S. V.	
3	Prof. Dr. Salunkhe M. N.	

I/c. Principal
K.N. Bhise Arts, Commerce &
Vinayakrao Patil Science College
Vidyanagar Bhosare, Dist- Solapur

Madha Taluka Shikshan Prasarak Mandal's
K N. Bhise Arts, Commerce and Vinayakrao Patil Science
College, Vidyanagar, Bhosare

Paranda Road, Kurduwadi, Tal- Madha, Dist Solapur Pin- 413208 (Maharashtra)

NAAC 'A' Grade (3.10 CGPA)

Madha Taluka Shikshan Prasarak Mandal's
 K. N. Bhise Arts, Commerce and Vinayakrao Patil Science College
 Vidyanagar, Bhosare.

Cultural Department

Name of the Activity :- **Essay Competition Participation List**
Year- 2022 - 2023

Sr. No	Mob. PRN No	Name of Student	Class	Signature
1		Ankita dhavale	B.A.II	A. B. Dhavale
2		Ameeta Bagal	B.A.II	Phanaji
3		Komal Shetye	B.A.II	P. V. Shetye
4		Pranali Bagal	B.A.II	P. L. Bagal
5		Rutuja Kote	B.A.II	R. S. Kote
6	7387341033	Sanjivane Gopalrao	B.A.I	S. S. Gopalrao
7	9011962094	Poonam Bhorale	B.A.I	P. D. Bhorale
8	8308346664	Pawar Kamal	B.A.I	Kamal Pawar
9	9503453390	Aishwarya Salunkar	B.A.I	Salunkar Ash
10	9359874775	Aarti Ingole	B.A.I	A. D. Ingole
11	7972291899	Aishwarya Salunke	B.A.I	A. S. Salunke
12	8381095327	Nikita Ghodake	B.A.I	N. N. Ghodake
13	8055965060	Bhagyashri Amale	B.Com.Fy	B. R. Amale
14	7558569096	Pand. Vaishnavi Vika	B.Com.Fy	Pand. V. V.
15	7249255794	Dhanshri Santoshkumar	B.Com.Fy	D. S. Santosh
16	8425035767	Yashwantrao Salyata	B.Com.Fy	S. M. Salyata
17	9975858915	Kumbhars Nehal	B.Com.Fy	S. V. Kumbhar
18	9657242163	Fatil Vaishnavi	B.Com.Fy	V. Fatil
19	8180015105	Shubhangi Binajdar	B.Com-I	S. A. Binajdar
20	9011340496	Janhavi Kadam	B.Com-I	J. Kadam
21	9607195529	Bongale kishor	B.Sc.III	K. B.
22	7757843526	Adlinge Akash Dipak	B.Sc.III	A. Adlinge
23	8459852115	Wagh Shubhangi	B.Sc.III	W.
24	9370560502	Anantkavale Sanika	B.Sc.I	S. A. Anantkavale
25	8080198144	Gavali Puja	B.Sc.I	G. Gavali
26	9699335701	Dhore supriya	B.Sc.I	D. Dhore
27	9322494829	Lokare pooja	B.Sc.I	P. Lokare
28	7038263383	Kabade Meghana	B.Sc.I	M. Kabade
29	9146859602	Jyugul Monali R	B.Sc.I	J. Jyugul
30	9284849304	Ubale. Gitanjali	B.Sc.I	U. Ubale
31	9022881192	Chavan Nikita B.	B.Sc.I	C. Chavan
32	9309006850	Pallavi Somnath Kapore	B.Sc.I	P. Kapore
33	9604962527	Gunjal sapana sunil	B.Sc.I	G. Gunjal
34	7219304757	Mehar sayli sanjay	B.Sc.I	S. S. Mehar
35	7219867195	shruti mtali	B.Sc.I	S. S. Mali

I/O. Principal

K. N. Bhise Arts, Commerce &
 Vinayakrao Patil Science College
 Paranda Road, Kurduwadi, Tal- Madha, Dist Solapur Pin- 413208 (Maharashtra)

(Saathi)

Date ___/___/___

● पर्यावरण संवर्धन : काळाची गरज ●

प्रत्येकाला निसर्गाच्या सानिध्यता स्वतःचा वेळ व्यतीत करायला नेहमी आवडत असतो. सर्वांनाच सुंदर हिरव्यागार निसर्गाचा सहवास हवा असतो. प्रत्येकालाच निसर्गस्य ठिकाणी भेटी देऊन तेथील सुंदरतेचा आनंद घ्यायला आवडत असतो. आपल्या आजूबाजूला असलेली ही हिरवीगार झाडे निसर्गाचे शोभा वाढवत असतात. या वृक्षांपासून आपल्याला नेहमी फायदाच होत असतो. आपल्या आजूबाजूला असलेले वृक्षा वातावरणातील कार्बन डायऑक्साईड शोषून घेतात व आपल्याला जीवनावश्यक असलेला ऑक्सिजन प्रदान करतात. वातावरणातील हवा स्वच्छ करण्यात वृक्षांमधून महत्वाची भूमिका बजावत असतात. आपल्याला जिवंत राहण्यासाठी पाणी शूष महत्वाचे आहे.

"निसर्ग माझा मित्र
निसर्ग माझा गुरू
निसर्ग माझी माय
मी त्याचे त्रेकल"

आज मानव प्रगतीमुळे पर्यावरण प्रदूषित होत आहे. प्राचीन काळात ऋषी मुनी आपल्या आत्म्या बद्दल अनेक वर्षे राहत असे.

हे वृक्षा पालस पडण्यासाठी पोषक वातावरण निर्म करतात? असंख्य फायदे आपल्याला या वृक्षांपासून मिळतात तरीही वृक्षतोड होताना आपल्याला दिसत असते. आपल्या आजूबाजूला असणाऱ्या वृक्षा पर्यावरण संतुलन राखण्यासाठी शूष महत्वाची भूमिका बजावत असतात.

पर्यावरण संवर्धन कोळ्याची गरज !

“ निसर्ग माझा मित्र
निसर्ग माझा गुरू
निसर्ग माझी माय
मी त्याचे भेकरू ”

पर्यावरण म्हणजे मानव यांचे अतुट नाते आहे. मानवाबरोबरच सर्व सजीव सृष्टी पर्यावरणाशी या-ना-त्या नात्याने जुळलेली आहे. निसर्गातील हवा, पाणी, वृक्ष - वनस्पती, जमीन, पक्षु - पक्षी आणि मानव प्राणी यांच्या नात्यात जेव्हा नैसर्गिक समतोल असतो..... तेव्हा पर्यावरण संतुलित आहे, असे म्हणतात. नैसर्गिक पर्यावरण हा सजीवांसाठी अनमोल ठेवा असल्याने तो आपण पुढील पिढ्यांसाठी व्यवस्थित जतन करून ठेवणे गरजेचे आहे. नव्हे आपली ती अत्यंत महत्त्वाची जबाबदारी आहे!

मानवाच्या अति हव्यासापोटी निसर्गाचा हास होत आहे आणि त्याला आपण विकास म्हणतो आहोत, परंतु आपल्याला हे कळत नाही आपण विकासाच्या नष्टी तर विनाशाच्या मार्गावर चालत आहोत. निसर्गाचे चक्र असंतुलित होण्याला मानसाचा स्वार्थ आणि वेजबाबदारपणा कारणीभूत आहे. पर्यावरण मानवाच्या अनियंत्रित हस्तक्षेपामुळे विविध पर्यावरणीय समस्या आज आपल्यासमोर उभ्या ठाकल्या आहेत. आज आपल्या जिवनातील खुपच दुःखदायक गोष्टी म्हणजे निसर्ग आपल्या पासून पुरावत चालला आहे. कृत्रिम विकासांमुळे “ मांस आणि निसर्गाचे अनमोल नाते ” तुटत चालत आहे हे आपण प्रत्येकाने लक्षात घ्यायला हवे !

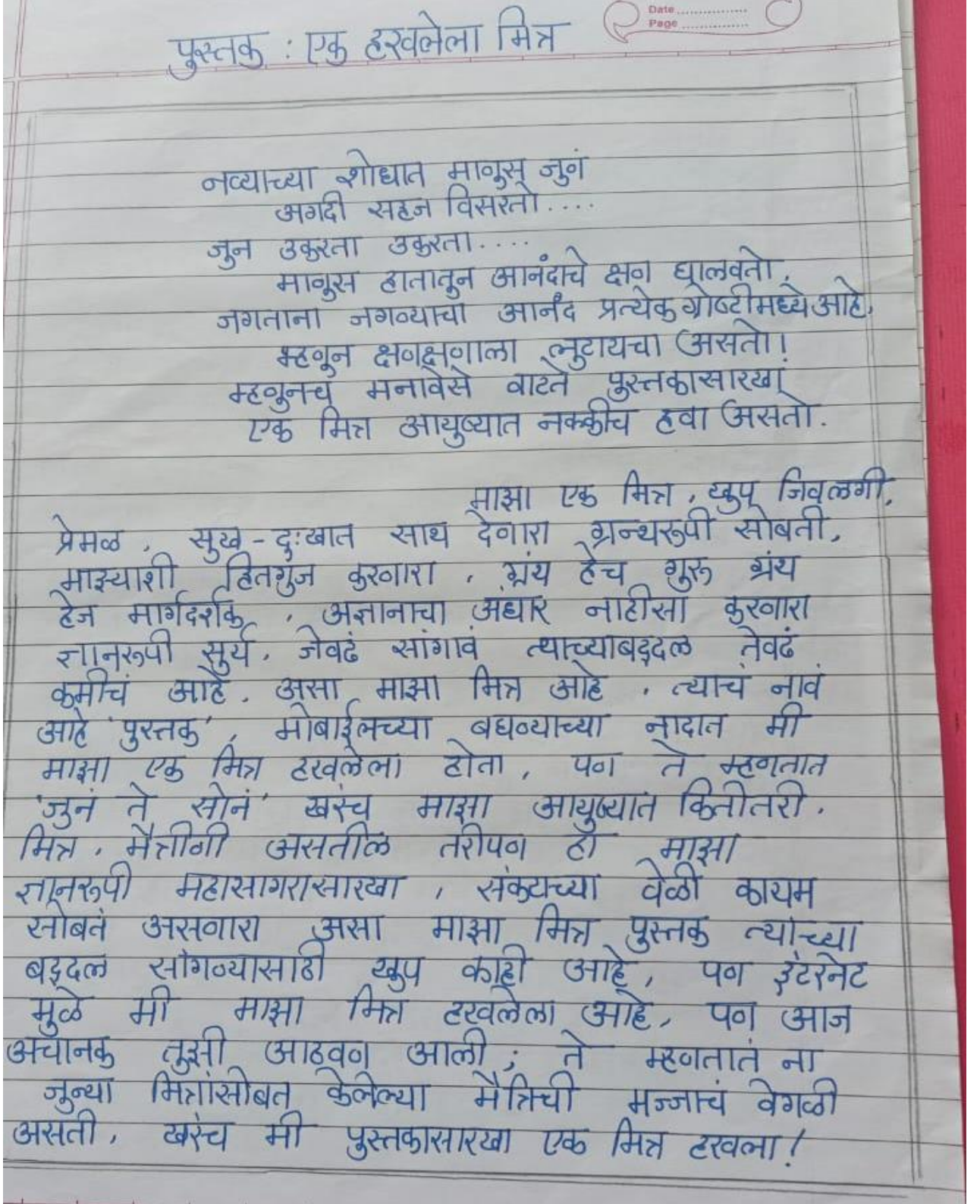

Madha Taluka Shikshan Prasarak Mandal's
K N. Bhise Arts, Commerce and Vinayakrao Patil Science
College, Vidyanagar, Bhosare
Paranda Road, Kurduwadi, Tal- Madha, Dist Solapur Pin- 413208 (Maharashtra)

NAAC 'A' Grade (3.10 CGPA)

Activity Report

Name of the Department/ Committee : **Cultural Department.**

Activity Report Year : **2022-23**

Name of the activity : **Trade festival and competition**

Date		Department	Coordinator Name
18-04-2023		Cultural	Dr. Waghmare V. B
Time	Venue	Activity for the class/ group	Nature of the activity
From 10.00am onwards	Seminar Hall	All faculties	Competition

Support/ Assistance: Cultural Committee Members

General information of the activity

Topic of the Activity	1) खाद्य पदार्थ 2) Electronic वस्तु 3) सेंद्रिय उत्पादने 4) कृषि उत्पादने 5) कपडे 6) स्वनिर्मित वस्तु 7) Stationary 8) Ayurvedic medicines 9) Services 10) Solar items
-----------------------	---

Objective	To give students an opportunity to develop their entrepreneur skills and give them a live experience of trading.
Methodology	Students select a product, purchase it at low price and sell in trade fair in college with profit.

Madha Taluka Shikshan Prasarak Mandal's
K N. Bhise Arts, Commerce and Vinayakrao Patil Science
College, Vidyanagar, Bhosare

Paranda Road, Kurduwadi, Tal- Madha, Dist Solapur Pin- 413208 (Maharashtra)

NAAC 'A' Grade (3.10 CGPA)

Outcome	Participating students got the platform to enhance their entrepreneur skills and their confidence boosted by gaining good profits
Participants No.	27



Proofs attached:

1. Notice	2. Photos
3. Student Participant List	4. Student Attendance list
5. Results	

Results : Trade Competition

Position	Name of the student	Class
First Prize	Mr. Dhaygude Rishikesh	S.Y.B.A
Second Prize	Ms. Bagal Sonali	F.Y.B.Sc
Third Prize	Ms. Bagal Sakshi Ms. Bagal Shivani	T.Y.B.Sc T.Y.B.Sc

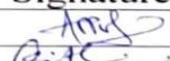
Faculty Judges :

Sr. No	Faculty Name	Signature
1	Prof. Dr. Pol A. P.	
2	Prof. Dr. Mohite S. V.	
3	Prof. Dr. Salunkhe M. N.	

I/c. Principal
K.N.Bhise Arts, Commerce &
Vinayakrao Patil Science College
Vidyanagar Bhosare, Dist-Solapur

Madha Taluka Shikshan Prasarak Mandal's
K N. Bhise Arts, Commerce and Vinayakrao Patil Science
College, Vidyanagar, Bhosare

Paranda Road, Kurduwadi, Tal- Madha, Dist Solapur Pin- 413208 (Maharashtra)

NAAC 'A' Grade (3.10 CGPA)

Madha Taluka Shikshan Prasarak Mandal's
 K. N. Bhise Arts, Commerce and Vinayakrao Patil Science College
 Vidyanagar, Bhosare.

Cultural Department

Name of the Activity :- Trade Festival Competition Participation List 18/04/2023
 Year- 2022 - 2023

Sr. No	Mob. No	Name of Student	Class and Subject	Signature
1	7387341033	Santivan P. K. Patil	B. A. I	Santivan P. K. Patil
2	8379877867	Mahek Shaikh	Mehendi	M.S. Shaikh
3	7555569056	Pand. Vaishnavi V. K.	B.com I	Pand. V.V.
4	8425035767	Yashraj S. Jadhav	B.com I	Yashraj S. Jadhav
5	9767471079	Pand. Vaishnavi V. K.	B.com I	Pand. V.V.
6	8055965060	Bhagyashri Amale	B.com I	B.A. Amale
7	7249255194	Dhanshal Kumble	B.com I	D.S. Kumble
8	8010551011	Tyansha Dabade	B.com I	T.R. Dabade
9	8379877867	Mahek Shaikh	B.com I	M.S. Shaikh
10	9860558173	Megha Chavan	B.Sc III	Megha Chavan
11	7498430553	Harshada Nalawade	B.Sc III	H.H. Nalawade
12	8180083630	Bagal Radhika	B.Sc III	Bagal R.
13	7709507137	Bagal Sakshi	B.Sc III	Bagal S.
14	8788772881	Godse Aaditi	B.Sc III	Aaditi Godse
15	8080997499	Dixit. Nrupur	B.Sc III	Dixit N.
16	8459852405	Wagh Shubhangi	B.Sc III	Wagh S.
17	9607195529	Bongale Kishor	B.Sc III	Bongale K.
18	7757843526	Aadlinge Aradh Dipak	B.Sc III	Aadlinge A.
19	9325624321	Anachar Rohidas Shivaji	B.Sc III	Anachar R.
20	8766061759	Talekar Swarnil Tahir	B.Sc III	S.L. Talekar
21	9763166185	Kale Samrath Ajmath	B.Sc III	Kale S.
22	8605102372	Rohit X. S. Swarnik	B.Sc III	Rohit X.
23	9511737570	Rushikesh Gichitkar	B.Sc III	Rushikesh G.
24	9146859602	Bagal Manali R	B.Sc I	Bagal M.R.
25	9284849304	Udale Gitanjali	B.Sc I	Udale G.
26	9022881192	Chavan Nikita B.	B.Sc I	Chavan N.B.
27	9689145919	Yadav Tejashri	B.Sc I	T.C. Yadav
28				
29				
30				
31				
32				
33				

I/c. Principal
 K. N. Bhise Arts, Commerce &
 Vinayakrao Patil Science College
 Vidyanagar Bhosare, Dist-Solapur

Madha Taluka Shikshan Prasarak Mandal's
**K N. Bhise Arts, Commerce and Vinayakrao Patil Science
College, Vidyanagar, Bhosare**

Paranda Road, Kurduwadi, Tal- Madha, Dist Solapur Pin- 413208 (Maharashtra)

NAAC 'A' Grade (3.10 CGPA)



Trade Festival 18/04/2023



Madha Taluka Shikshan Prasarak Mandal's
**K N. Bhise Arts, Commerce and Vinayakrao Patil Science
College, Vidyanagar, Bhosare**

Paranda Road, Kurduwadi, Tal- Madha, Dist Solapur Pin- 413208 (Maharashtra)

NAAC 'A' Grade (3.10 CGPA)



Trade Festival 18/04/2023



Madha Taluka Shikshan Prasarak Mandal's
K N. Bhise Arts, Commerce and Vinayakrao Patil Science
College, Vidyanagar, Bhosare

Paranda Road, Kurduwadi, Tal- Madha, Dist Solapur Pin- 413208 (Maharashtra)

NAAC 'A' Grade (3.10 CGPA)

Activity Report

Name of the Department/ Committee : **Cultural Department.**

Activity Report Year : **2022-23**

Name of the activity : **Elocution competition**

Date		Department	Coordinator Name
19-04-2023		Cultural	Mr. Shejul B. R.
Time	Venue	Activity for the class/ group	Nature of the activity
From 10.00am onwards	Seminar Hall	All faculties	Competition

Support/ Assistance: Cultural Committee Members

General information of the activity

Topic of the Activity	1) अंधश्रद्धा 2) राष्ट्र निर्मिती मध्ये युवकांचे योगदान 3) ग्रामीण विकास
-----------------------	--

Objective	To create awareness among the students of the Current topics of India and enhance their skills in expressing their views in written form.
Methodology	Students have to visualise, Express and represent their idea in an Essay form.
Outcome	Students got the platform to express their view, enhance their skills and overall Personality development.
Participants No.	06

Madha Taluka Shikshan Prasarak Mandal's
K N. Bhise Arts, Commerce and Vinayakrao Patil Science
College, Vidyanagar, Bhosare

Paranda Road, Kurduwadi, Tal- Madha, Dist Solapur Pin- 413208 (Maharashtra)

NAAC 'A' Grade (3.10 CGPA)

Madha Taluka Shikshan Prasarak Mandal's
K N. Bhise Arts, Commerce and Vinayakrao Patil Science
College, Vidyanagar, Bhosare

Paranda Road, Kurduwadi, Tal- Madha, Dist Solapur Pin- 413208 (Maharashtra)

NAAC 'A' Grade (3.10 CGPA)

Proofs attached:

1. Notice	2. Photos
3. Student Participant List	4. Student Attendance list
5. Results	

Results : Elocution Competition

Position	Name of the student	Class	Signature
First Prize	Ms. Deshmukh Vaishnavi	F.Y.B.Sc	<i>Deshmukh</i>
Second Prize	Ms. Divate Anita	F.Y.B.A	<i>A. Divate</i>
Third Prize	Mr. Kamble Mahesh	S.Y.B.Sc	<i>M. Kamble</i>

Faculty Judges :

Sr. No	Faculty Name	Signature
1	Prof. Dr. Kshirsagar S. S.	<i>[Signature]</i>
2	Prof. Phulwale S. P.	<i>[Signature]</i>

[Signature]
I/c.Principal
K.N.Bhise Arts,Commerce &
Vinayakrao Patil Science College
Vidyanagar Bhosare,Dist-Solapur

Madha Taluka Shikshan Prasarak Mandal's
K N. Bhise Arts, Commerce and Vinayakrao Patil Science
College, Vidyanagar, Bhosare
Paranda Road, Kurduwadi, Tal- Madha, Dist Solapur Pin- 413208 (Maharashtra)

NAAC 'A' Grade (3.10 CGPA)

Madha Taluka Shikshan Prasarak Mandal's
K. N. Bhise Arts, Commerce and Vinayakrao Patil Science College
Vidyanagar, Bhosare.

Cultural Department

Name of the Activity -: **Elocution Competition Participation List**
Year- 2022 - 2023

Sr. No	PRN No	Name of Student	Class	Signature
1	7387341033	Simriti Golehar	B. A. I	S.S. Golehar
2	9975858915	Jambhar Snehal	B. com. I	Jambhar Snehal
3	7822869012	Gunode tejasmuni	B. sc	Gunode tejasmuni
4	815733638	Anita Divate	B. A. II	Anita Divate
5	1971095011	Disha K. Vaishnav	B. sc. I	Disha K. Vaishnav
6	0158233884	Prakash Kamble	B. SC. III	Prakash Kamble
7	20200325000	68483		
8				
9				
10				
11				
12				
13				
14				
15				
16				
17				
18				
19				
20				
21				
22				
23				
24				
25				
26				
27				
28				
29				
30				
31				
32				
33				

I/c. Principal
K. N. Bhise Arts, Commerce &
Vinayakrao Patil Science College
Vidyanagar Bhosare, Dist Solapur

Madha Taluka Shikshan Prasarak Mandal's
**K N. Bhise Arts, Commerce and Vinayakrao Patil Science
College, Vidyanagar, Bhosare**

Paranda Road, Kurduwadi, Tal- Madha, Dist Solapur Pin- 413208 (Maharashtra)

NAAC 'A' Grade (3.10 CGPA)



Elocution Competition 19/04/2023



Madha Taluka Shikshan Prasarak Mandal's
K N. Bhise Arts, Commerce and Vinayakrao Patil Science
College, Vidyanagar, Bhosare
Paranda Road, Kurduwadi, Tal- Madha, Dist Solapur Pin- 413208 (Maharashtra)

NAAC 'A' Grade (3.10 CGPA)

Activity Report

Name of the Department/ Committee : **Cultural Department.**

Activity Report Year : **2022-23**

Name of the activity : **Debate competition**

Date		Department	Coordinator Name
19-04-2023		Cultural	Mr. Goyal Akash M.
Time	Venue	Activity for the class/ group	Nature of the activity
From 10.00am onwards	Seminar Hall	All faculties	Competition

Support/ Assistance: Cultural Committee Members

General information of the activity

Topic of the Activity	1) पारंपारिक शिक्षण कि व्यावसायिक शिक्षण 2) Love Marriage का Arranged Marriage 3) फॅशन : व्यक्ति स्वातंत्र्य कि स्वराचार
-----------------------	--

Objective	To create awareness among the students of the Current topics of India and enhance their skills in expressing their views in Debate form.
Methodology	Students have to visualise, Express and represent their idea in an Debate form.
Outcome	Students got the platform to express their view, enhance their skills and

Madha Taluka Shikshan Prasarak Mandal's
K N. Bhise Arts, Commerce and Vinayakrao Patil Science
College, Vidyanagar, Bhosare

Paranda Road, Kurduwadi, Tal- Madha, Dist Solapur Pin- 413208 (Maharashtra)

NAAC 'A' Grade (3.10 CGPA)

Madha Taluka Shikshan Prasarak Mandal's
K N. Bhise Arts, Commerce and Vinayakrao Patil Science
College, Vidyanagar, Bhosare
Paranda Road, Kurduwadi, Tal- Madha, Dist Solapur Pin- 413208 (Maharashtra)

NAAC 'A' Grade (3.10 CGPA)

Participants No.	overall Personality development. 20
------------------	--



Proofs attached:

1. Notice	2. Photos
3. Student Participant List	4. Student Attendance list
5. Results	

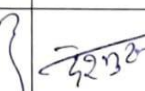
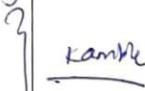
Results : Debate Competition

Winner	Name of the student	Signature
व्यावसायिक शिक्षण	Sakshi bagal Tejaswini bansode Chavan Keshav Samruddhi kadam	
Love Marriage	Deshmukh Vaishnavi Deshmukh sushant Jagtap Maheshwar Godage shruti	
3) फॅशन : व्यक्ति स्वातंत्र्य	Bagal Sakshi Bagal Radhika Kamble dhanashri Birajdar shubhangi	

Faculty Judges :

Sr. No	Faculty Name	Signature
1	Prof. Waghmare V. B.	
2	Prof. Dr. Anupama P. Pol.	

I/c. Principal
K.N.Bhise Arts,Commerce &
Vinayakrao Patil Science College
Vidyanagar Bhosare,Dist-Solapur

Madha Taluka Shikshan Prasarak Mandal's
K. N. Bhise Arts, Commerce and Vinayakrao Patil Science
College, Vidyanagar, Bhosare
 Paranda Road, Kurduwadi, Tal- Madha, Dist Solapur Pin- 413208 (Maharashtra)

NAAC 'A' Grade (3.10 CGPA)

Madha Taluka Shikshan Prasarak Mandal's
 K. N. Bhise Arts, Commerce and Vinayakrao Patil Science College
 Vidyanagar, Bhosare.

Cultural Department
 Name of the Activity -: Vad Vivad Competition Participation List
 Year- 2022 - 2023

Sr. No	PRN No	Name of Student	Class	Signature
1		Dhenge Dnyaneshwar Dhe		
2	8010472906	Dhenge Dnyaneshwar	B.A.T	D.S.Kamble
3	72049285794	Dhanshri Kamble	B.com I	S.A. Birajdar
4	8180015105	Shubhangi Birajdar	B.com I	M.S. Shaikh
5	8379873867	Mahesh Shaikh	B.com I	
6	8425035767	Yashraj Sajat	B.com	Pand.V.V
7	7658669096	Band Vaishnavi Vikas	B.com I	
8	8180083630	Bagal Radhika	B.sc III	
9	7709607137	Bagal Sakshi	B.sc III	
10	78228440122	Bansode Tejawini	B.S.C I	
11	8080745645	Kadam Samsuddh	B.sc - I	
12	9730609677	Deshmukh Sushant	B.com III	
13	8080918325	Sonmukhe Nikhil	B.A I	
14	4621817232	Maheshwar Sajat	B.com II	
15	9921043019	Deshmukh Vaishnavi	B.sc. I & II	
16	839058420	Chavan Keshav	D.sc II	
17	7058937933	Godage Shushti	BA I	S.D. Sawale
18	9767472709	Patil Yashraj	B.sc. I.	
19	9975858915	Kumbhar Snehal	B.com - I	S.V. Kumbhar
20	87999770617	Mahini Bhagyavant	B.S.C. I	
21				
22				
23				
24				
25				
26				
27				
28				
29				
30				
31				
32				
33				

I/c. Principal
 K.N. Bhise Arts, Commerce &
 Vinayakrao Patil Science College
 Vidyanagar Bhosare, Dist- Solapur

Madha Taluka Shikshan Prasarak Mandal's
**K N. Bhise Arts, Commerce and Vinayakrao Patil Science
College, Vidyanagar, Bhosare**

Paranda Road, Kurduwadi, Tal- Madha, Dist Solapur Pin- 413208 (Maharashtra)

NAAC 'A' Grade (3.10 CGPA)



Debate Competition 19/04/2023



Madha Taluka Shikshan Prasarak Mandal's
K N. Bhise Arts, Commerce and Vinayakrao Patil Science
College, Vidyanagar, Bhosare
Paranda Road, Kurduwadi, Tal- Madha, Dist Solapur Pin- 413208 (Maharashtra)

NAAC 'A' Grade (3.10 CGPA)

Activity Report

Name of the Department/ Committee : **Cultural Department.**

Activity Report Year : **2022-23**

Name of the activity : **Fancy Dress competition**

Date		Department	Coordinator Name
20-04-2023		Cultural	Dr. N. D. Deshmukh
Time	Venue	Activity for the class/ group	Nature of the activity
From 10.00am onwards	Seminar Hall	All faculties	Competition

Support/ Assistance: Cultural Committee Members

General information of the activity

Topic of the Activity	Fancy Dress
Objective	To Enhance the stage daring of the students and give exposure to their skills.
Methodology	Students have to dress up in a Fancy Way and present himself/herself on stage in front of audience.
Outcome	Students got the platform to enhance their skills and overall Personality development.
Participants No.	11

Proofs attached:

1. Notice	2. Photos
3. Student Participant List	4. Student Attendance list
5. Results	

Madha Taluka Shikshan Prasarak Mandal's
K N. Bhise Arts, Commerce and Vinayakrao Patil Science
College, Vidyanagar, Bhosare

Paranda Road, Kurduwadi, Tal- Madha, Dist Solapur Pin- 413208 (Maharashtra)

NAAC 'A' Grade (3.10 CGPA)

Results : Fancy Dress Competition

Position	Name of the student	Class
First Prize	Miss Tejaswini Bansode	F.Y.B.Sc
Second Prize	Miss Nikita Jagtap	S.Y.B.A
Third Prize	Mr. Shivraj Kamble	S.Y.B.Com

Faculty Judges :

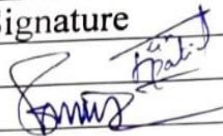
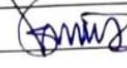
Sr. No	Faculty Name	Signature
1	Prof. Patil M. M.	
2	Prof. Phulwale S. P.	

I/c. Principal
K.N. Bhise Arts, Commerce &
Vinayakrao Patil Science College
Vidyanagar Bhosare, Dist-Solapur

Madha Taluka Shikshan Prasarak Mandal's
K N. Bhise Arts, Commerce and Vinayakrao Patil Science
College, Vidyanagar, Bhosare
Paranda Road, Kurduwadi, Tal- Madha, Dist Solapur Pin- 413208 (Maharashtra)

NAAC 'A' Grade (3.10 CGPA)

Cultural Department

Name of the Activity :- **Fancy Dress Competition Participation List**
Year- 2022 - 2023

Sl. No	PRN No	Name of Student	Class	Signature
1	7709401137	Bhargal Sakshi	B.Sc-III	Bhargal
2	8080997499	Dixit Noopur	B.Sc. III	Dixit
3	8020198144	Puja Gravali	BSC. I	Pujali
4	9960166597	Mafuzi Magas	BSC. I	M Magas
5	7219267195	Shrutika Mali	BSC. I	S. Mali
6	7822844012	Tejaswini Bansode	BSC. I	Tejaswini
7	-11-	Nikita Jagtap	B.A III	
8		Kranthika Pabli	B.Sc. III	Pabli
9		Afrin Jamadar	B.Sc. III	Jamadar
10		Vrushali Netake	BSC. III	Netake
11		Shivadina Kamble	B.COM. II	S. Kamble
12				
13				
14				
15				
16				
17				
18				
19				
20				
21				
22				
23				
24				
25				
26				
27				
28				
29				
30				
31				
32				
33				

I/c. Principal
K.N. Bhise Arts, Commerce &
Vinayakrao Patil Science College
Vidyanagar Bhosare, Dist- Solapur

Madha Taluka Shikshan Prasarak Mandal's
**K N. Bhise Arts, Commerce and Vinayakrao Patil Science
College, Vidyanagar, Bhosare**
Paranda Road, Kurduwadi, Tal- Madha, Dist Solapur Pin- 413208 (Maharashtra)

NAAC 'A' Grade (3.10 CGPA)



Fancy Dress Competition 20/04/2023



Madha Taluka Shikshan Prasarak Mandal's
**K N. Bhise Arts, Commerce and Vinayakrao Patil Science
College, Vidyanagar, Bhosare**

Paranda Road, Kurduwadi, Tal- Madha, Dist Solapur Pin- 413208 (Maharashtra)

NAAC 'A' Grade (3.10 CGPA)

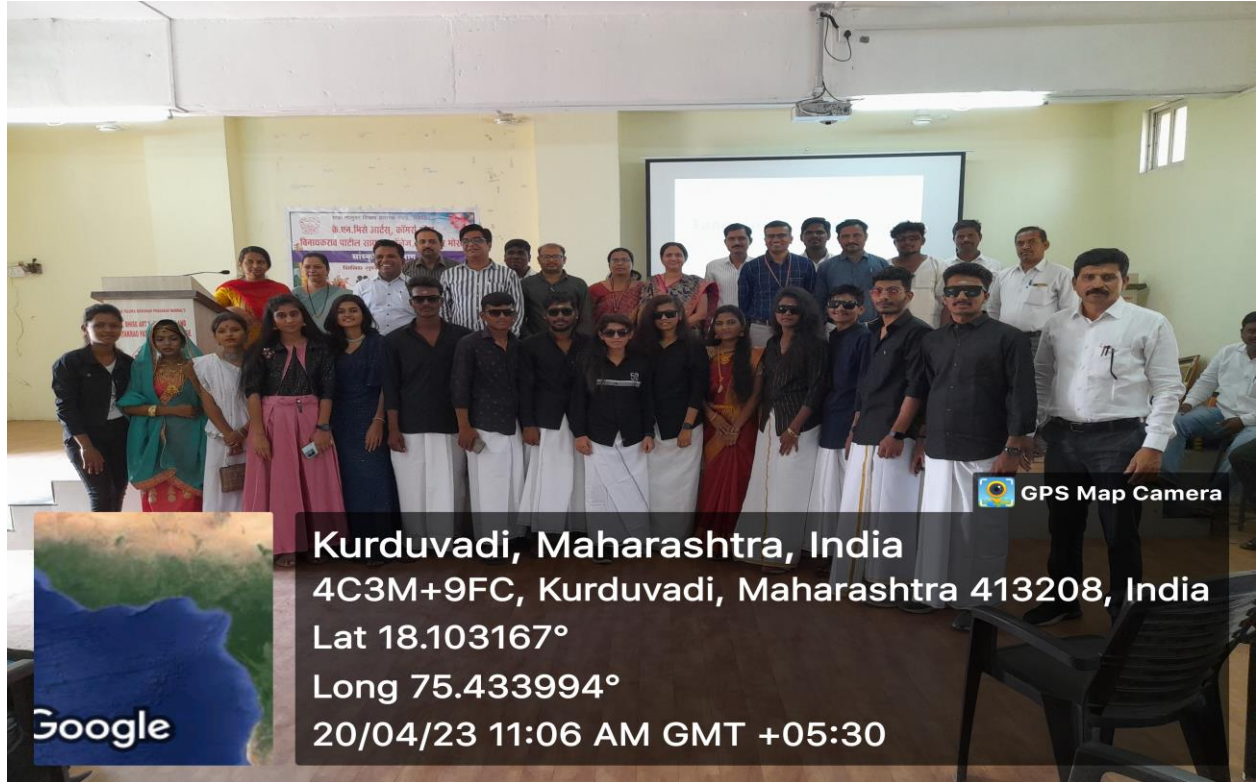

Fancy Dress Competition 20/04/2023



Madha Taluka Shikshan Prasarak Mandal's
K N. Bhise Arts, Commerce and Vinayakrao Patil Science
College, Vidyanagar, Bhosare
Paranda Road, Kurduwadi, Tal- Madha, Dist Solapur Pin- 413208 (Maharashtra)

NAAC 'A' Grade (3.10 CGPA)

Activity Report

Name of the Department/ Committee : **Cultural Department.**

Activity Report Year : **2022-23**

Name of the activity : **Miss Match Dress competition**

Date		Department	Coordinator Name
21-04-2023		Cultural	Mr. Goyal Akash M.
Time	Venue	Activity for the class/ group	Nature of the activity
From 10.00am onwards	Seminar Hall	All faculties	Competition

Support/ Assistance: Cultural Committee Members

General information of the activity

Topic of the Activity	Fancy Dress
-----------------------	-------------

Objective	To Enhance the stage daring of the students and give exposure to their skills.
Methodology	Students have to dress up in a Miss Match Way and present himself/herself on stage in front of audience.
Outcome	Students got the platform to enhance their skills and overall Personality development.
Participants No.	09

Proofs attached:

1. Notice	2. Photos
3. Student Participant List	4. Student Attendance list
5. Results	



Madha Taluka Shikshan Prasarak Mandal's
K N. Bhise Arts, Commerce and Vinayakrao Patil Science
College, Vidyanagar, Bhosare
Paranda Road, Kurduwadi, Tal- Madha, Dist Solapur Pin- 413208 (Maharashtra)

NAAC 'A' Grade (3.10 CGPA)

Results : Miss match Dress Competition

Position	Name of the student	Class
First Prize	Miss Sakshi Bagal	T.Y.B.Sc
Second Prize	Miss Shivani Bagal	T.Y.B.Sc
Third Prize	A. Miss Nikita Jagtap B. Mr Keshav Chavan	S.Y.B.A S.Y.B.Sc

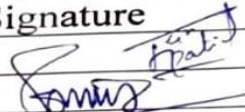
Faculty Judges :

Sr. No	Faculty Name	Signature
1	Prof. Patil M. M.	
2	Prof. Phulwale S. P.	

I/c. Principal
K.N.Bhise Arts, Commerce &
Vinayakrao Patil Science College
Vidyanagar Bhosare, Dist-Solapur

Madha Taluka Shikshan Prasarak Mandal's
K N. Bhise Arts, Commerce and Vinayakrao Patil Science
College, Vidyanagar, Bhosare
Paranda Road, Kurduwadi, Tal- Madha, Dist Solapur Pin- 413208 (Maharashtra)

NAAC 'A' Grade (3.10 CGPA)

K. N. Bhise Arts, Commerce and Vinayakrao Patil Science College
Vidyanagar, Bhosare.

Cultural Department

Name of the Activity -: **Miss Match Day Competition Participation List**
Year- 2022 - 2023

Sr. No	PRN No	Name of Student	Class	Signature
1	7709507137	Bagal Sakshi	B.Sc-III	Bagal.
2	8080997499	Dixit. Neeraj	B.Sc III	dixit.
3		Nikita Jaytap	B.A III	
4	889058420	Keshav Chavan	B.Sc. II	
5	8080745615	Samrudhika Kadam	B.Sc I	
6	9766319014	Vrushali Netake	B.Sc III	
7	8459852405	Wagh. Shubhangi. Salik	B.Sc. III	
8	9527350699	Patil Karantika Shubhan	B.Sc III	
9	9508982411	Shivani Bayeest	B.Sc III	
10				
11				
12				
13				
14				
15				
16				
17				
18				
19				
20				
21				
22				
23				
24				
25				
26				
27				
28				
29				
30				
31				
32				
33				

I/c. Principal
K.N. Bhise Arts, Commerce &
Vinayakrao Patil Science College
Vidyanagar Bhosare, Dist-Solapur

Madha Taluka Shikshan Prasarak Mandal's
**K N. Bhise Arts, Commerce and Vinayakrao Patil Science
College, Vidyanagar, Bhosare**

Paranda Road, Kurduwadi, Tal- Madha, Dist Solapur Pin- 413208 (Maharashtra)

NAAC 'A' Grade (3.10 CGPA)



Miss Match Competition 21/04/2023



Madha Taluka Shikshan Prasarak Mandal's
K N. Bhise Arts, Commerce and Vinayakrao Patil Science
College, Vidyanagar, Bhosare
Paranda Road, Kurduwadi, Tal- Madha, Dist Solapur Pin- 413208 (Maharashtra)

NAAC 'A' Grade (3.10 CGPA)

Activity Report

Name of the Department/ Committee : **Cultural Department.**

Activity Report Year : **2022-23**

Name of the activity : **Nature Photography competition**

Date		Department	Coordinator Name
21-04-2023		Cultural	Mr. Goyal Akash M.
Time	Venue	Activity for the class/ group	Nature of the activity
Submit before 10.00 am	Seminar Hall	All faculties	Competition

Support/ Assistance: Cultural Committee Members

General information of the activity

Topic of the Activity	Competition : Take a Photograph of Nature and submit in given time.
Objective	To create awareness among the students about the Environment issues and enhance their skills of photography.
Methodology	Students have to identify and present the beauty of nature in the form of photograph.
Outcome	Students got the platform to enhance their skills and overall Personality development.
Participants No.	22



Madha Taluka Shikshan Prasarak Mandal's
K N. Bhise Arts, Commerce and Vinayakrao Patil Science
College, Vidyanagar, Bhosare
Paranda Road, Kurduwadi, Tal- Madha, Dist Solapur Pin- 413208 (Maharashtra)

NAAC 'A' Grade (3.10 CGPA)

Proofs attached:

1. Notice	2. Photos
3. Student Participant List	4. Student Attendance list
5. Results	

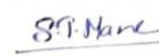
Results : Nature Photography Competition

Position	Name of the student	Class	Signature
First Prize	Mr.Mane subhash tukaram	F.Y.B.A	
Second Prize	Ms.Sayyad Taslim Nijam	F.Y.B.A	
Third Prize	1. Ms. Bansode Tejaswini R.	S.Y.B.Sc	

Faculty Judges :

Sr. No	Faculty Name	Signature
1	Prof. Patil M. M.	
2	Prof. Phulwale S. P.	

I/c.Principal
K.N.Bhise Arts,Commerce &
Vinayakrao Patil Science College
Vidyanagar Bhosare,Dist-Solapur

Madha Taluka Shikshan Prasarak Mandal's
K N. Bhise Arts, Commerce and Vinayakrao Patil Science
College, Vidyanagar, Bhosare
 Paranda Road, Kurduwadi, Tal- Madha, Dist Solapur Pin- 413208 (Maharashtra)

NAAC 'A' Grade (3.10 CGPA)

K. N. Bhise Arts, Commerce and Vinayakrao Patil Science College
 Vidyanagar, Bhosare.

Cultural Department

Name of the Activity -: **Nature Photography Competition Participation List**
Year- 2022 – 2023

Sr. No	PRN No	Name of Student	Class	Signature
1	9370025771	Sabhash mane	BA - I	Smane
2		Ramdas salunke	BA - I	RS
3		VIKAS SUDHAR	BA - I	VS
4	9503453390	Aishwarya Sabarwal	B-A-I	Sabarwal A.P
5	8080916325	Nikhil SONMUKHE	B-A-I	N.N.S
6	9359874775	Aarti Ingole	B-A-I	A. D. Ingole
7	8668548801	Asif Akbar Sattar	B.com I	Asif Sattar
8	8275633899	Sourabh Hanumanthrao	B.com I	Hanumanthrao
9	9284906828	Shriyash. Subhdev neekar	B.com-I	Shriyash
10	9533303914	Navnath Navidas Pansare	B.com-I	Navnath
11		Vaibhav sudhir gade	B.com I	Vaibhav
12	8425035767	Yashwanth siddhanta	B.com I	Yashwanth
13	7558569056	Bhand Vaishnavi Vikas	B.com I	Bhand V.V.
14	7249255194	Dhanshri Kambale	B.com I	D.s.kambale
15	8180083630	Bagal Radhika	B.sc III	Bagal
16	7709507137	Bagal Sakshi	B.sc III	Bagal
17	9607095529	Bongale kishor	B.sc III	KB
18	8459852405	Wagh Shubhangi	B.sc III	Wagh
19	7038263383	Kabade Meghana	B.sc - I	Kabade
20	9922111253	ARSHIYA .A. DALWALE	B.sc - I	Arshiya Dalwale
21	4503766490	Shivraj Chaugule	B.sc I	Shivraj
22	9666755710	Utkal Kumar Shinde	B.sc I	Utkal
23				
24				
25				
26				
27				
28				
29				
30				
31				
32				
33				

Madha Taluka Shikshan Prasarak Mandal's-

I/c. Principal
 K.N. Bhise Arts, Commerce &
 Vinayakrao Patil Science College
 Vidyanagar Bhosare, Dist-Solapur

Madha Taluka Shikshan Prasarak Mandal's
**K N. Bhise Arts, Commerce and Vinayakrao Patil Science
College, Vidyanagar, Bhosare**
Paranda Road, Kurduwadi, Tal- Madha, Dist Solapur Pin- 413208 (Maharashtra)

NAAC 'A' Grade (3.10 CGPA)

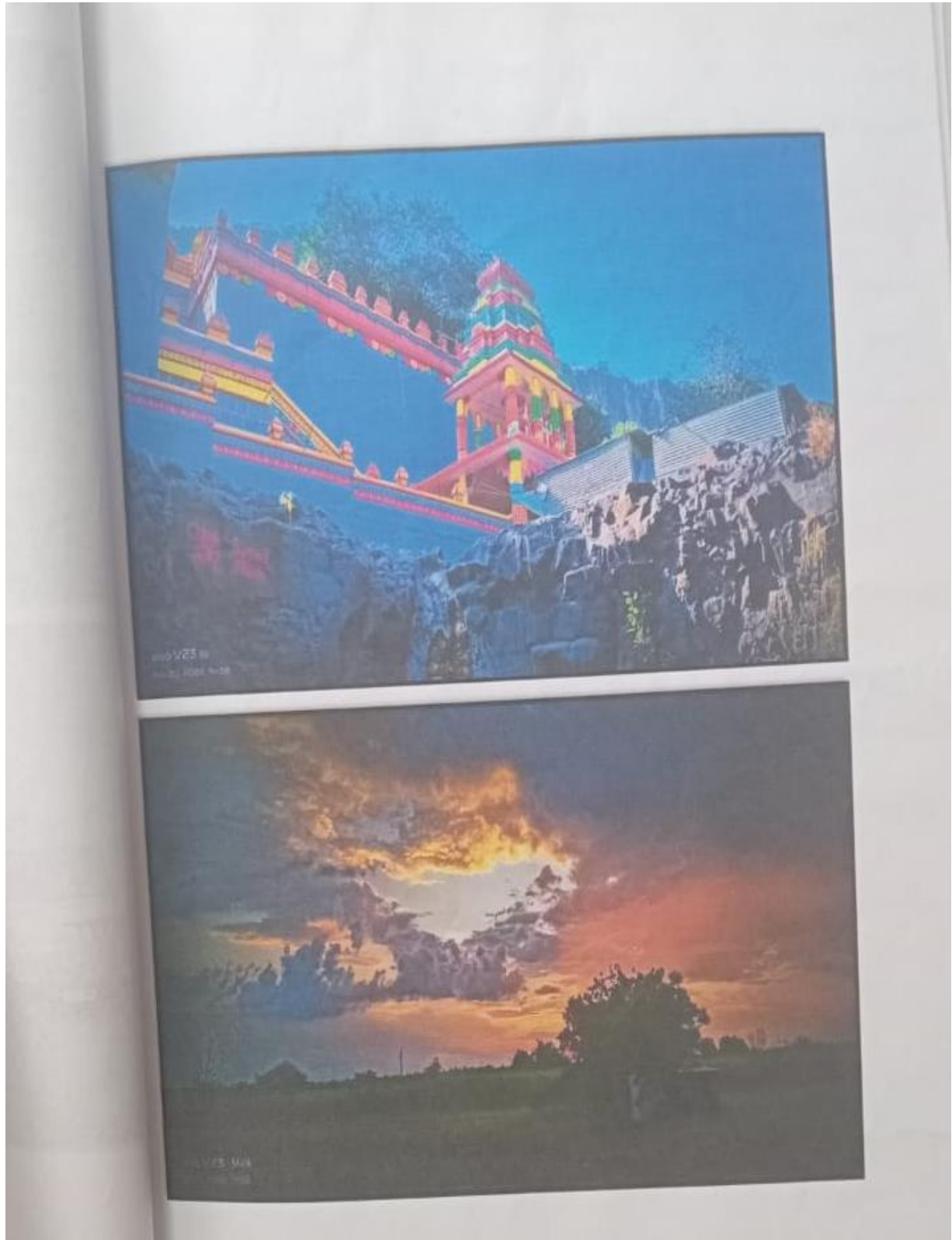

Madha Taluka Shikshan Prasarak Mandal's
**K N. Bhise Arts, Commerce and Vinayakrao Patil Science
College, Vidyanagar, Bhosare**

Paranda Road, Kurduwadi, Tal- Madha, Dist Solapur Pin- 413208 (Maharashtra)

NAAC 'A' Grade (3.10 CGPA)

Name - Subhash Tukaram mane
class - B-A I
K-N. Bhise college, kurduwadi



Madha Taluka Shikshan Prasarak Mandal's
K N. Bhise Arts, Commerce and Vinayakrao Patil Science
College, Vidyanagar, Bhosare
Paranda Road, Kurduwadi, Tal- Madha, Dist Solapur Pin- 413208 (Maharashtra)

NAAC 'A' Grade (3.10 CGPA)

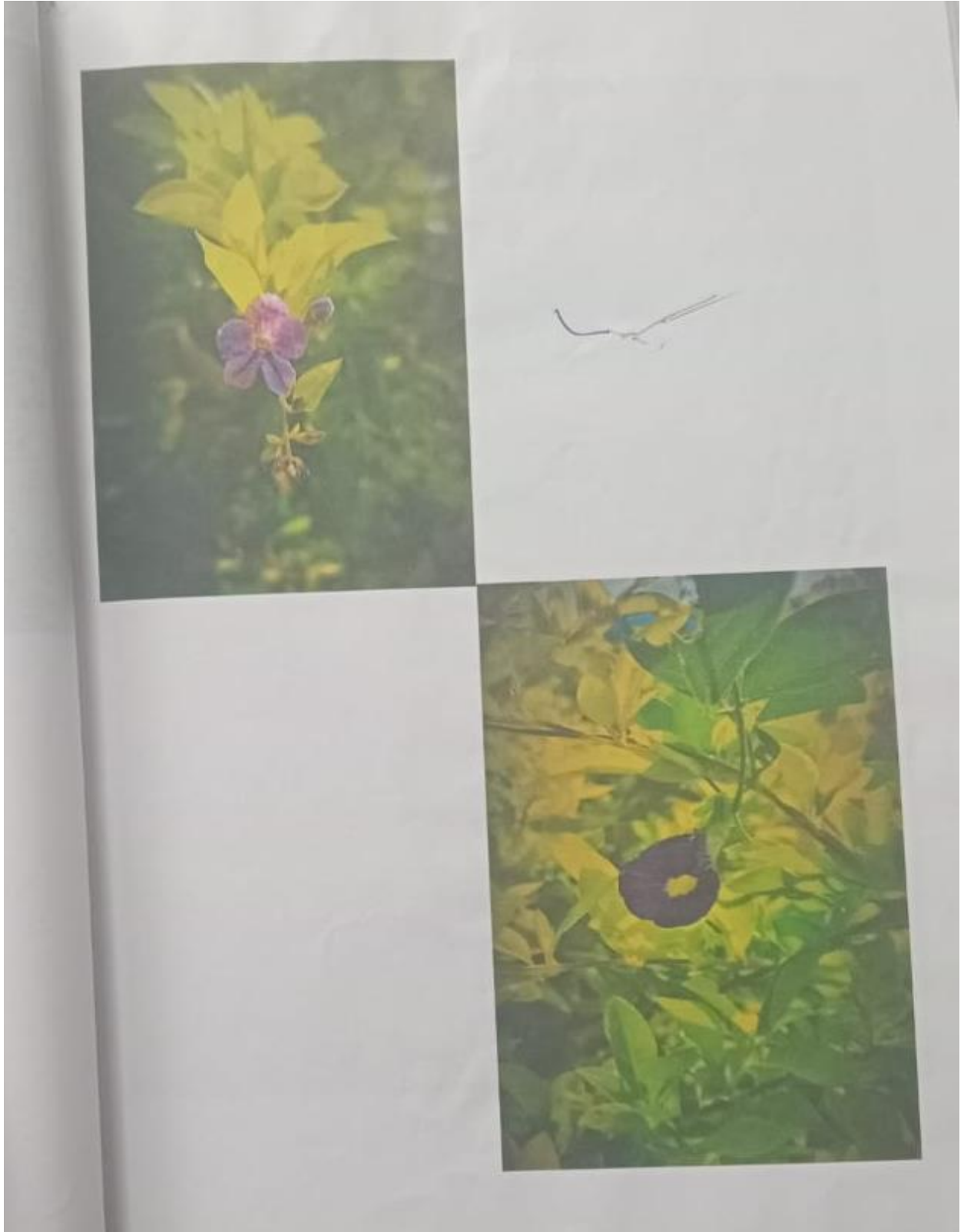

Madha Taluka Shikshan Prasarak Mandal's
**K N. Bhise Arts, Commerce and Vinayakrao Patil Science
College, Vidyanagar, Bhosare**
Paranda Road, Kurduwadi, Tal- Madha, Dist Solapur Pin- 413208 (Maharashtra)

NAAC 'A' Grade (3.10 CGPA)

Name - Taslim nijam sayyad
class - B-A-I
K-N. Bhise College, Kurduwadi



Madha Taluka Shikshan Prasarak Mandal's
K N. Bhise Arts, Commerce and Vinayakrao Patil Science
College, Vidyanagar, Bhosare
Paranda Road, Kurduwadi, Tal- Madha, Dist Solapur Pin- 413208 (Maharashtra)

NAAC 'A' Grade (3.10 CGPA)

Activity Report

Name of the Department/ Committee : **Cultural Department.**

Activity Report Year : **2022-23**

Name of the activity : **Traditional Dress competition**

Date		Department	Coordinator Name
24-04-2023		Cultural	Mr. Goyal Akash M.
Time	Venue	Activity for the class/ group	Nature of the activity
From 10.00am onwards	Seminar Hall	All faculties	Competition

Support/ Assistance: Cultural Committee Members

General information of the activity

Topic of the Activity	Traditional Dress
Objective	To Enhance the stage daring of the students and give exposure to their skills.
Methodology	Students have to dress up in a Traditional Way and present himself/herself on stage in front of audience.
Outcome	Students got the platform to enhance their skills and overall Personality development.
Participants No.	18

Proofs attached:

1. Notice	2. Photos
3. Student Participant List	4. Student Attendance list
5. Results	

Madha Taluka Shikshan Prasarak Mandal's
K N. Bhise Arts, Commerce and Vinayakrao Patil Science
College, Vidyanagar, Bhosare
Paranda Road, Kurduwadi, Tal- Madha, Dist Solapur Pin- 413208 (Maharashtra)

NAAC 'A' Grade (3.10 CGPA)

Madha Taluka Shikshan Prasarak Mandal's
K N. Bhise Arts, Commerce and Vinayakrao Patil Science
College, Vidyanagar, Bhosare
Paranda Road, Kurduwadi, Tal- Madha, Dist Solapur Pin- 413208 (Maharashtra)

NAAC 'A' Grade (3.10 CGPA)

Results : Traditional Dress Competition

Position	Name of the student	Class
First Prize	Miss Bansode Tejaswini	F.Y.B.Sc
Second Prize	Miss Nikita Jagtap	T.Y.B.A
Third Prize	Miss Sanika Bagal	T.Y.B.Sc

Faculty Judges :

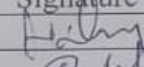
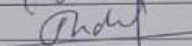
Sr. No	Faculty Name	Signature
1	Prof. Dr. Kadam A. H.	
2	Prof. Dr. Londhe S. V.	

I/c. Principal
K.N.Bhise Arts, Commerce &
Vinayakrao Patil Science College
Vidyanagar Bhosare, Dist- Solapur

Madha Taluka Shikshan Prasarak Mandal's
K N. Bhise Arts, Commerce and Vinayakrao Patil Science
College, Vidyanagar, Bhosare
 Paranda Road, Kurduwadi, Tal- Madha, Dist Solapur Pin- 413208 (Maharashtra)

NAAC 'A' Grade (3.10 CGPA)

Madha Taluka Shikshan Prasarak Mandal's
 K. N. Bhise Arts, Commerce and Vinayakrao Patil Science College
 Vidyanagar, Bhosare.

Cultural Department

Name of the Activity :- **Traditional Day Competition Participation List**
 Year- 2022 - 2023

Sr. No	PRN No	Name of Student	Class	Signature
1	7709507137	Bagal Sakshi	Bsc III	Bagal
2	9607195529	Bongale kishor	Bsc III	Bongale
3	8080198144	Puja Gevali	Bsc-I	Puja
4	989960766597	Mayuri Magar	Bsc-I	Magar
5	7038267383	Megha Kabade	Bsc-I	Kabade
6	9328494829	Pooja Lakare	Bsc-I	Lakare
7	9699335701	Sudhita Chhore	Bsc-I	Chhore
8	7219867195	Shruti Mali	Bsc-I	Mali
9	806121353	Dhane Rajeshai	Bsc-I	Rajeshai
10		Jayshri Nikita	B.A II	Nikita
11		Devolcar Poonam	B-sc. II	Devolcar
12		Anvita Archar	B-sc. II	Archar
13		Vaishnavi Kale	B-sc. II	Kale
14		Arati Kumbhe	B-sc. II	Kumbhe
15		Ichare Babkrushna	B.S. III	Ichare
16		Khame Bharat	B.S. III	Bharat
17		Keshav Chavan	B-sc II	Chavan
18		Mame Subhash	B.A I	Mame
19				
20				
21				
22				
23				
24				
25				
26				
27				
28				
29				
30				
31				
32				
33				

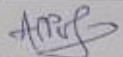
I/c. Principal
 K.N. Bhise Arts, Commerce &
 Vinayakrao Patil Science College
 Vidyanagar Bhosare, Dist-Solapur

Madha Taluka Shikshan Prasarak Mandal's
**K N. Bhise Arts, Commerce and Vinayakrao Patil Science
College, Vidyanagar, Bhosare**

Paranda Road, Kurduwadi, Tal- Madha, Dist Solapur Pin- 413208 (Maharashtra)

NAAC 'A' Grade (3.10 CGPA)



Traditional Dress Competition 24/04/2023

